

Rainin MicroPro 20 and MicroPro 300 Pipetting System

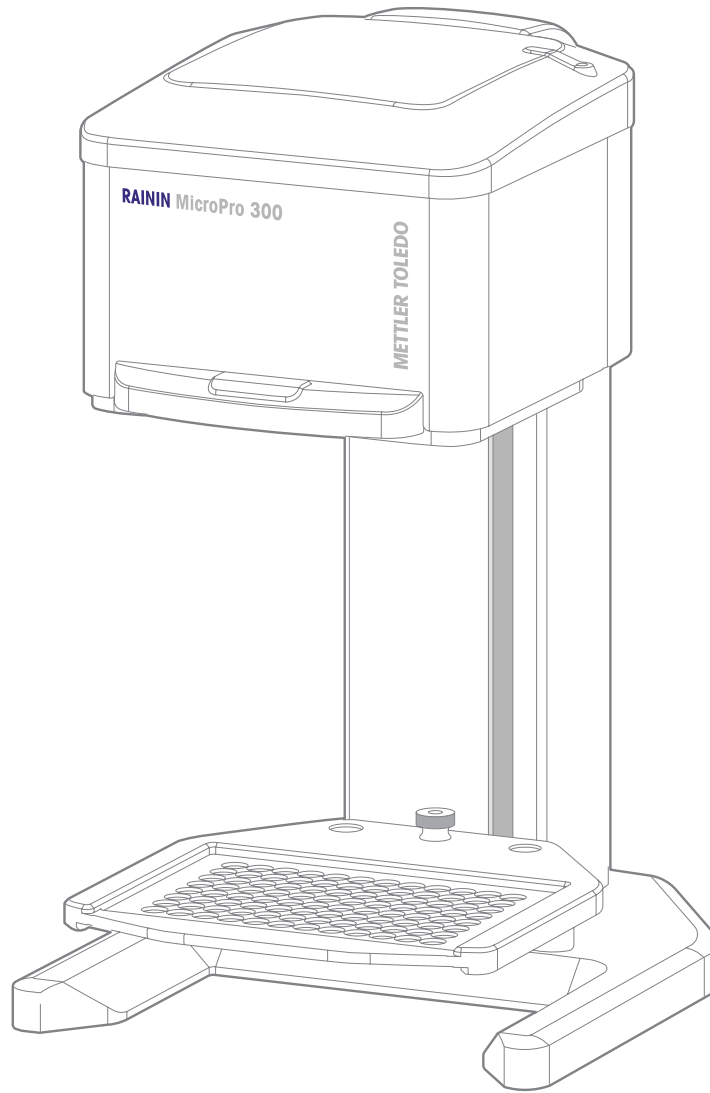

METTLER TOLEDO

Table of Contents

1. Introduction	6
1.1 Models	6
1.2 Features	6
1.3 Security and Connections	7
1.4 Name Plate	7
1.5 Warranty	7
2. Safety	8
2.1 Intended Use	8
2.2 Terms and Symbols	8
2.3 Caution – General Use	9
3. Setup	10
3.1 Unpacking the Box	10
3.2 Instrument Setup	11
3.3 Tablet Setup	11
4. Operation	12
4.1 Connection Screen	12
4.1.1 Available Pipettors	12
4.1.2 Using the Simulator	13
4.2 Interface Overview	14
4.2.1 Function Selection Tabs	14
4.2.2 Program Graphical Area	14
4.2.3 Lower Selection Tabs	16
4.2.4 Instrument Status Image	16

Table of Contents

4.3	Pipetting Functions	17
4.3.1	Pipette with Mix	17
4.3.2	Repeat Dispense	21
4.3.3	Variable Dispense	23
4.3.4	Dilute with Mix	25
4.3.5	Multi-Aspirate with Mix	26
4.3.6	Custom	28
4.4	Favorites	35
4.4.1	List Overview	35
4.4.2	Saving Programs	36
4.4.3	Versions	37
4.5	Tips	38
4.5.1	Load	38
4.5.2	Eject	39
4.5.3	Manual Tip Load	39
4.5.4	Types	40
4.6	Pipetting Depth Recall	41
4.7	Nest 96/384 Conversion	42
4.8	Settings	43
4.8.1	Overview	43
4.8.2	Pipetting	44
4.8.3	Instrument Info	45
4.8.4	Lighting + Audio	46
4.8.5	Calibration Status	47
4.8.6	Liquid Classes	48
4.8.7	Containers	51
4.8.8	Import/Export	52
4.8.9	Data Logs	56

Table of Contents

4.9	Advanced Settings	58
4.9.1	Overview	58
4.9.2	Advanced Pipetting	58
4.9.3	Calibration	60
4.9.4	Reminder	63
4.9.5	Analysis	64
4.9.6	Security	65
4.9.7	Technician	66
4.9.8	Beta	66
5.	Troubleshooting	67
5.1	General Errors	67
5.2	Wireless Connection	68
6.	Care and Maintenance	69
6.1	Cleaning	69
6.2	Decontamination	69
6.3	Calibration and Service	70
7.	Technical Specifications	71
7.1	Performance Specifications	71
7.2	Weight and Dimensions	71
7.3	Power Supply	71
7.4	Test Conditions	72
7.5	Environmental	72
8.	Ordering	73
9.	Regulatory Information	74

© 2023 Mettler Toledo. All rights reserved. Reproduction of any part of this manual by any means or in any form is prohibited without prior written consent of Mettler-Toledo Rainin, LLC. The information in this manual is subject to change without notice. Modifications to the product described in this manual may also be made at any time.

Rainin and MicroPro are trademarks of Mettler Toledo and its affiliates in the United States and/or other countries. The Bluetooth® word mark and logos are registered trademarks owned by Bluetooth SIG, Inc. and any use of such marks by Mettler Toledo is under license. All other trademarks and registered trademarks are the property of their respective holders.

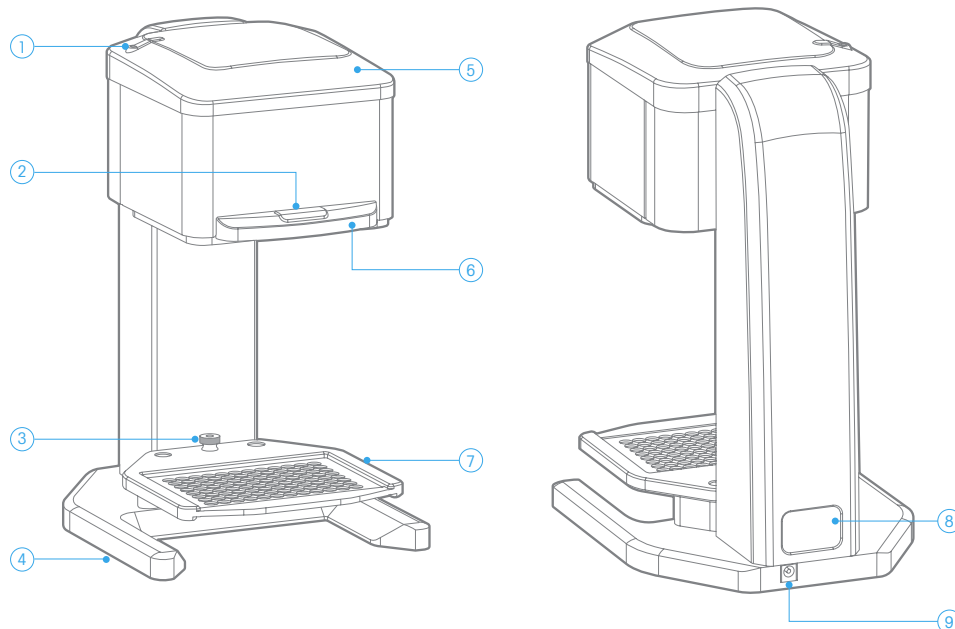

<p>① Status LED</p>	<p>Blue – Instrument is on, and connected to a tablet Red – Instrument is on, but NOT connected to a tablet Flashing Red – Instrument is on, NOT connected to a tablet, and has gone into Power Save Mode Flashing Red and Blue – Instrument is on, but NOT connected to the correct power supply</p>
<p>② RUN Button</p>	<p>Tactile button, press for all operations (see Section 4)</p>
<p>③ Nest Thumb Nut</p>	<p>Loosen and remove to convert nest from 96 to 384 configuration, and vice versa (see Section 4.7)</p>
<p>④ Base</p>	<p>Solid machined base with opening for reservoir</p>
<p>⑤ Pipetting Head</p>	<p>Easily movable and re-positionable</p>
<p>⑥ Handle</p>	<p>Grab this area to move the pipetting head up/down</p>
<p>⑦ Convertible Nest</p>	<p>Solid platform for use during operation, can be converted for use in 96/384 configuration (see Section 4.7)</p>
<p>⑧ Name Plate</p>	<p>ID label with Serial Number (see Section 1.3)</p>
<p>⑨ Power Connector</p>	<p>Connect only to the power supply provided</p>

1. Introduction

Congratulations on your purchase of the Rainin MicroPro pipetting system. This innovative compact instrument packs an enormous feature set that offers unprecedented capability and value.

1.1 Models – MicroPro 20 and MicroPro 300

This manual covers both the MicroPro 20 and the MicroPro 300 models. All functions within the app for each model are the same. The only difference between the models is the effective volume range and relative performance. For more details, see [Section 7.1](#) below.

1.2 Features

Multi-Function Pipetting

There are a total of six different pipetting functions, including Pipette with Mix, Repeat Dispense, Variable Dispense, Dilute with Mix, Multi-Aspirate with Mix, and Custom.

Intuitive Touchscreen User Interface

Large, easy to use touchscreen interface with direct access to all major functions on one screen.

RingLock Tip Loading System

Patented tip load and eject system that is simple and easy to use.

PDR Function (Pipetting Depth Recall)

Easily save, control and recall the pipetting depth of each plate, container or reservoir.

Touchless Tip Ejection

Easily eject used tips without the need to touch them directly, avoiding possible contamination.

Saved Programs

Save and organize a practically limitless number of programs, for quick and easy use.

10x Speed Control

Ten unique levels of control over both aspirate and dispense speeds.

96/384 Convertible Nest

Easily convert the nest for either 96 or 384 channel pipetting.

1.3 Security and Connections

The instrument and tablet communicate wirelessly via a Bluetooth® connection. The connection is controlled through the MicroPro Series app. For more information, see [Section 3](#) below.

The application itself can be password protected, but if a higher level of security is required, the standard security features of the tablet are available. Use those to disable outside connections such as WiFi or add password protection to the tablet itself. However make sure to keep it Bluetooth enabled, otherwise the tablet will not be able to connect to the instrument.

1.4 Name Plate

The instrument has a single ID label, located on the back. This label contains some regulatory markings as well as the Model and Serial Number of the instrument.

1.5 Warranty

One Year Limited Warranty

The Rainin warranty is a conditional warranty that covers defects in parts or workmanship, as well as ensures proper performance of the pipette as shipped by the factory. It does not cover damage such as that caused by dropping, splash up of chemicals or if the pipette has been repaired or recalibrated by any service facility which is not authorized by Rainin. This warranty is effective for one year following purchase or service in our lab.

Service Agreements

A service agreement that would cover the cost of most repairs or replacement for the life of the agreement, may be available. Please contact your local representative for more details.

2. Safety

Read all safety warnings and precautions prior to installing, operating or servicing this instrument. Always operate the MicroPro in accordance with this User Manual.

2.1 Intended Use

The MicroPro is a semi-automated liquid transfer system designed for use in laboratories for research and development, as well as training and education. This system is capable of accurately and precisely transferring liquid into and out of 96/384 well microplates. The functional volume range is from 2 μL to 300 μL , depending on the model number. The applications include, but are not limited to, clinical research, chemistry, life sciences and biotechnology.

This pipetting system is intended for indoor use only and should only be operated by qualified and appropriately trained personnel. Any operator must read this operating manual carefully prior to use and must follow all the instructions and warnings included herein.

This manual is considered part of the system and should be kept close by and readily accessible. The latest version of this manual, in all available languages, can always be found at www.mt.com/rainin.

2.2 Terms and Symbols

All safety warnings and cautions are identified using the following terms and symbols:

WARNING

A hazardous situation with medium to high risk, that could possibly result in serious injury (or death) as well as damage to the instrument and/or laboratory.

CAUTION

A hazardous situation with low risk, that could result in minor injury, damage to the instrument and/or laboratory, data loss, or improper functionality.

NOTICE

A situation that may lead to material damage, damage to the instrument and/or laboratory, data loss or improper functionality.

**General Hazard**

Refer to the User Manual.

**Crushing Hazard**

Risk of personal injury.

**Electrical Hazard**

Risk of electric shock.

2.3 Caution – General Use

**CAUTION**

Keep control over the pipette head while lifting or moving the instrument. It moves relatively easily and could present a pinching hazard.

**CAUTION**

This instrument should only be used for the intended purpose as stated in [Section 2.1](#). Any other use may create a hazardous condition and lead to instrument damage and/or improper functionality.

The use of accessories and spare parts other than those approved by Rainin may create a hazardous condition and lead to instrument damage and/or improper functionality.

3. Setup

The MicroPro pipetting system is surprisingly simple to setup. Follow the instructions below to get started.

3.1 Unpacking the Box

Everything you need to get started is included with your new MicroPro instrument. Inside the well-packed box, you will find the following:

1. MicroPro 20 or 300 Instrument
2. Power supply
3. Tablet + stand with pre-loaded MicroPro Controller app

Check the box to ensure all the items are present and that there are no signs of shipping damage. If any items are damaged or missing please contact Rainin in the U.S. or your local Mettler Toledo office. In the U.S. call: +1 800 4 RAININ (800 472-4646) or email techsupport@rainin.com. Outside the U.S. go to www.mt.com/rainin and use the Contact button in the navigation bar.

Carefully remove all the items from the box. Use caution when removing the instrument. It is not heavy, but the head will be free to move once removed from the protective foam. Keep the box and packaging for transporting the instrument and/or returning it for authorized service.

3.2 Instrument Setup

The ideal workspace for the Rainin MicroPro is a clean dry bench that is near an electrical outlet and protected from vibration, drafts and direct sunlight.

Set the instrument on the bench and plug in the provided power supply. The power supply will be a small box with a cord on each end, similar to a laptop power supply. Simply plug the round end into the back of the instrument and the standard power plug into the electrical outlet. Once plugged in the instrument will automatically power up.



WARNING

To reduce the risk of electric shock, only use the power supply and cord provided. Do not modify the power supply or cord in any way. Ensure that the power supply, cord and connector on the instrument are undamaged prior to use.

3.3 Tablet Setup

Please be sure to read the user manual provided by the tablet manufacturer and follow the instructions for powering on and setting up the tablet.

It is recommended to fully charge the tablet prior to the first use. If possible, keep it plugged in during use to ensure there are no interruptions while using the instrument.



NOTE: The MicroPro Controller app will already be pre-installed on the tablet. This icon will be on the main screen upon startup.

To get started, simply press on the MicroPro Controller app icon to open the user interface. See [Section 4](#) below for more information on operation.

4. Operation



4.1 Connection Screen

4.1.1 Available Pipettors

When starting up, by default your tablet will try to connect to the last pipettor that it was connected to. However, if it is unable to find that particular instrument and/or you press the Cancel button, the screen will show a list of all available pipettors within range of the wireless connection. Select the desired instrument and choose to connect. Or, choose Use Simulator.

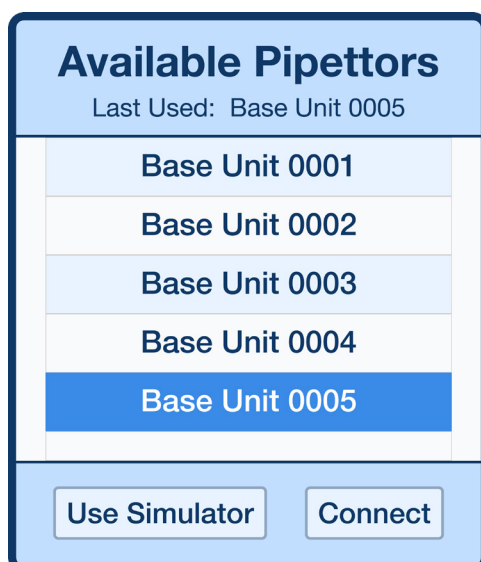

4.1.2 Using the Simulator

If you choose to use the simulator, all the features of the app will still be available. You will be able to create/modify/save programs, as you normally would. In addition, while in Simulation Mode the RUN button will always be available on the main screen. This will actually allow you to dry-run any program without needing to be connected to an instrument.

Note that there is a version of the simulator that is equivalent to each MicroPro model number. So, you will need to select the desired version of the simulator that you wish to use.

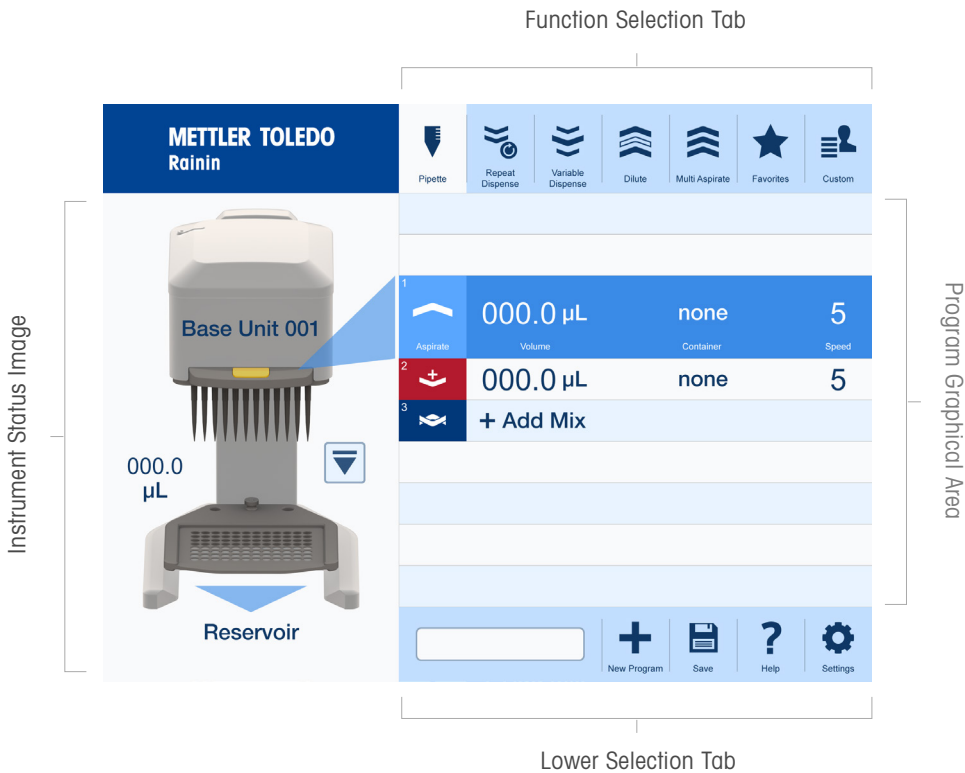

4.2 Interface Overview

4.2.1 Function Selection Tabs

Across the top of the main screen are the Function Selection Tabs. There is a tab for each of the various pipetting modes. Clicking on any of these tabs will bring you to that specific mode. In addition, the second to last tab is for the Favorites section. Clicking here will bring you to the Favorites section where all your saved programs reside. The last tab is for Custom Programs, where you have the freedom to create any type of program you might need.

4.2.2 Program Graphical Area

This area shows all the steps of the program in an intuitive spreadsheet-style format. The active step is highlighted in blue and larger than the other steps. At any given time, if the run button is pressed, the active step is what will be executed. All the steps below the active step are what comes next in order from top to bottom. As each step is executed, they move upward. The previous step will move above the active step and be greyed out.

Within each step, there are four columns. From left to right, these are the Step Type Icon, Volume, Container Name and Speed. The only exceptions are in Mix steps and within some of the special steps inside Custom Programs. For a Mix step, the Container Name field shows the total number of mixes.

To edit a specific step, simply click anywhere on that step and a pop-up will appear. This will allow you to edit all the parameters of that step. Depending on the mode, various other options may be available; such as Add Mix, Add Dispense, Edit All, etc. For more details, see the specific pipetting mode sections.

Below, are each of the Step Type symbols and their definitions. For more details on how each one is used, see [Section 4.3](#) below.

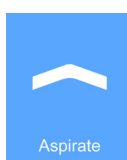

Aspirate

Represents a normal aspirate step.

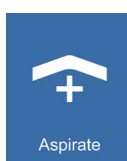

Aspirate with Turnaround (Reverse Pipette)

Very similar to a normal aspirate step, but in this case a small extra amount of liquid will be added to the desired volume. This is used when there are multiple dispenses in order to ensure accuracy.

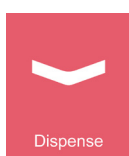
**Dispense**

Represents a normal dispense step.

**Mix**

Represents a normal mix step.

**Purge**

Represents a purge step, where all liquid will be cleared from the tips.

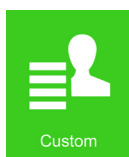
**Custom**

This is shown as a placeholder during the creation of a custom program. Once the step type has been defined, this icon will be replaced by the appropriate symbol.

**Instructions**

Found only under custom programs, this step is used to display instructions for the user on the screen during the program.

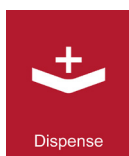
**Dispense with Blowout**

Very similar to a normal dispense step, but in this case the operation continues through the end of the dispense, purging any remaining liquid that may be in the tips.

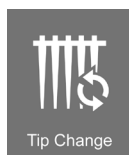
**Tip Change**

Represents a normal tip eject and/or load cycle. This step type is only available in custom programs.

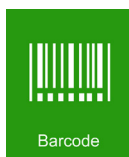
**Barcode**

Allows the user to capture and record a barcode using a Bluetooth-enabled scanner. Limited validation of the barcode can also be configured.

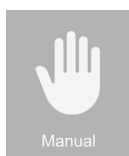
**Manual**

Used to manually aspirate and dispense liquid in defined increments that are adjustable while running a program.

4.2.3 Lower Selection Tabs

Across the bottom of the screen are the Lower Selection Tabs. The first tab or area shows the name of the current program being run or edited. If the program has been edited but not saved, an asterisk (*) will appear next to the name. Pressing on this area will take you straight to a filtered view of the [Favorites](#) section, only including programs of the same type.

The next tab will be either the New Program or Purge function. If a program is only being edited and has not yet started running, then the New Program function will be displayed. Pressing on this will clear the current program from the screen, providing a clean slate with which to start over. However, a warning will be displayed just to make sure you really intended to do this. If a program has already started running, then the Purge function will be displayed. Pressing on this will cancel the program and purge all liquid from the tips. Again, a warning will be displayed to ensure this is really what you intended to do.

The next tab is the Save Program function. For more information on this feature, see the Favorites section below. Then, there is the Help function. Pressing this will take you to this complete user manual with clickable links in the table of contents. Finally, the last tab is the Settings tab. For more information see the [Settings](#) section below.

4.2.4 Instrument Status Image

On the left hand side of the screen, there is an image of the instrument. This will show the current status of the unit and will actively update during the running of any program.

The name of the instrument will be displayed on the head of the pipettor. The liquid level in the tips will be shown on the left and further defined by the tips filling up with blue liquid in the image. At the bottom of the image, the name of the container that corresponds with the active step in the program will be shown. If no specific container is selected, then the area will be left blank. To the right of the image, next to the tips, will be the EJECT button. For more details, see the [Tips](#) section below.

Note that the color of the RUN button on the instrument image will match the model unit that you are using. The button will be orange/yellow for the MicroPro 300 and will be red for the MicroPro 20.

4.3 Pipetting Functions

Step	Function	Volume	Container	Speed
1	Aspirate	250.0 µL	Reservoir	8
2	Repeat Dispense	250.0 µL	none	8
3	Variable Dispense	100.0 µL	mix = 3	4

4.3.1 Pipette with Mix

The standard Pipette with Mix function will allow you to complete a single aspirate and then dispense with or without a mix. Simply press on each step to edit them. When pressing on the Aspirate step, the following pop-up will appear:

Volume	Source	Speed
250.0 µL	Reservoir	5

Source Options: None, < Create New >, Test 1, **Reservoir**, Rounded Bottom 2

Buttons: Liquid #2, Ok, Cancel

Within this pop-up window you can edit the volume, select the desired container, edit the speed and select a liquid class. To edit the volume, simply use the keypad to enter in the desired volume in μL . From the list of containers, you can select any of the pre-existing containers, select none or choose to create a new one. See [Section 4.6](#) for details on creating a new container. Note that this is the container that liquid will be aspirated from.

To edit the speed, just select the desired value from 1 to 10. Once you have finished making your selections or changes, simply press OK to exit the pop-up window. To undo your changes simply press CANCEL to exit the pop-up window.

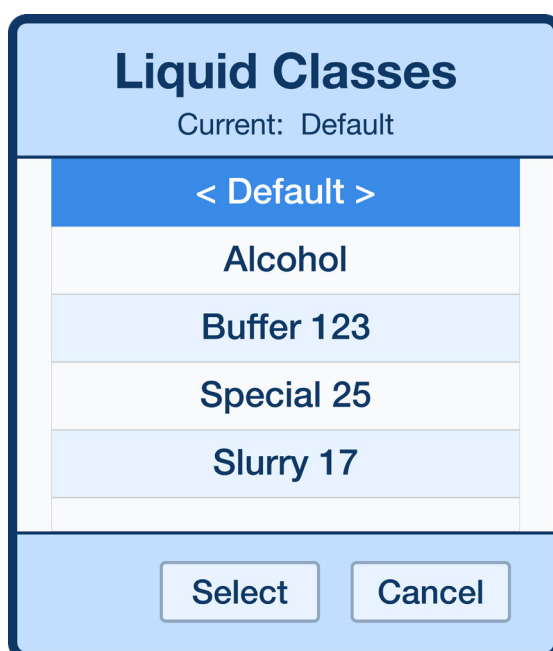

To change the liquid class, simply pressing on the liquid class name opens the separate pop-up window shown above. From here, you can select from any liquid class that has already been created. For more information on creating and using liquid classes, see [Section 4.8.6](#).

250.0 μ L			Rounded Bottom 2			5	
Volume			Destination			Speed	
1	2	3	None			1	6
4	5	6	< Create New >			2	7
7	8	9	Test 1			3	8
.	0	\times	Reservoir			4	9
			Rounded Bottom 2			5	10
						Ok	Cancel

Pressing on the dispense step will display the pop-up window above. Similarly to the aspirate popup window, you can edit the volume, select a container and edit the speed. Since this is a simple pipette program the volume is automatically carried over from the aspirate step. Editing it here will update it for both steps since it must always be equal in this type of program. The container and speed functions work identically, except this container will be the one that liquid is dispensed into.

100.0 μ L			3		5		
Mix Volume			Mixes		Speed		
1	2	3	0	5	1	6	
4	5	6	1	6	2	7	
7	8	9	2	7	3	8	
.	0	\times	3	8	4	9	
			4	9	5	10	
						Ok	Cancel

To add a mix step, press on the Add Mix step located just below the dispense step. The pop-up window above will be displayed. Here you will be able to edit the mix volume, the total number of mixes and the speed.

NOTE: To remove a mix step from a program after it has been added, simply change the number of mixes to zero and press OK.

Once you have the setup completed, you are now ready to run the program. Below is a series of steps walking you through how to run a simple pipette program:

1. Verify that the appropriate tips are loaded.
2. Ensure the selected aspirate container is either in the nest or in the reservoir area.
3. Grab the handle and slowly lower the head until it is at the desired height or all the way to the Z-Stop if you are using a saved container (see [Section 4.6](#)).
4. Press the RUN button on the front of the instrument to aspirate.
5. Raise the head up so that the tips are out of the liquid and you have room to change the container.
6. Ensure the selected dispense container is either in the nest or in the reservoir area.
7. Grab the handle and slowly lower the head until it is at the desired height or all the way to the Z-Stop if you are using a saved container.
8. Press the RUN button on the front of the base unit to dispense.
9. Raise the head up, so that the tips are out of the liquid. Then press the RUN button to return as directed.

CAUTION

The tips must be out of the liquid otherwise you risk sucking liquid back up into the tips. (see pop-up window below)



Step	Aspirate	Volume	Container	Speed
1	+	250.0 µL	Reservoir	8
2	∩	50.0 µL	none	8
3	∩	50.0 µL	none	8
4	∩	50.0 µL	none	8
5	++	N/A	Purge	

4.3.2 Repeat Dispense

The Repeat Dispense function allows you to complete a single aspirate, then dispense a series of equal amounts. The default is two dispense steps. Similarly, press on each step to edit them. When pressing on the aspirate step, the following pop-up window will be displayed:

Within this window, you can select the desired container and edit the speed. However, the aspirate volume is calculated directly from the dispense values and is therefore not editable here.

Pressing on any of the repeat dispense steps will bring up the pop-up window below. Here you can edit the repeated volume for each dispense, select the desired container, edit the speed and choose how many repeat dispenses will be completed. The system is limited to a maximum of 16 repeat dispenses and, depending on the volume entered, may be restricted further based on the total available volume of the instrument (20 μL or 300 μL) depending on the model.

50.0 μL <small>Dispense Volume</small>	Rounded Bottom 2 <small>Destination</small>	5 <small>Speed</small>	3 <small>Repeats</small>
1 2 3	None	1 6	1 6 11
4 5 6	< Create New >	2 7	2 7 12
7 8 9	Test 1	3 8	3 8 13
. 0 \times	Reservoir	4 9	4 9 14
	Rounded Bottom 2	5 10	5 10 15
			Ok Cancel

A fast and easy way to add or remove dispense steps is to simply swipe one of the steps to the left. This will reveal a green DUPLICATE button as well as a red REMOVE button. Pressing the DUPLICATE button will add a copy of that step below the step that was swiped. Pressing the REMOVE button will delete that step.

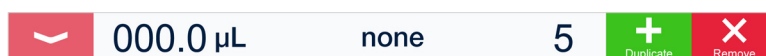

NOTE: When there are just two steps, only the DUPLICATE button will be available. This is because there must always be at least two dispenses in a Repeat Dispense program.

Running a Repeat Dispense program is similar to the simple Pipette program. The main difference is that there will be multiple dispense steps of equal volume. However there will also be a Purge step at the end in order to get rid of the small extra volume that was aspirated in order to ensure repeat dispense accuracy.

METTLER TOLEDO Rainin

Pipette Repeat Dispense Variable Dispense Dilute Multi Aspirate Favorites Custom

Base Unit 001

000.0 µL

Reservoir

Step	Aspirate	Volume	Container	Speed
1	+	130.0 µL	Reservoir	8
2	∩	50.0 µL	none	8
3	∩	30.0 µL	Rounded Bottom 2	8
4	∩	50.0 µL	none	8
5	+ Dispense			
6	∩+	N/A	Purge	

Program #3

New Program Save Help Settings

4.3.3 Variable Dispense

The Variable Dispense function allows you to complete a single aspiration, then dispense a series of variable amounts. The default is two dispense steps. Similarly, press on each step to edit them. When pressing on the Aspirate step, the pop-up window and options displayed will be the same as that shown for the Repeat Dispense function. Again, the aspiration volume will be calculated based on the dispense volumes.

Pressing on a Dispense step will bring up the standard Dispense edit pop-up window, identical to that of the simple pipette function. The main difference is that each dispense step will add up to generate the total aspirate volume. The default is two steps, but to add more, simply press on the "+ Dispense" row. Pressing on this row will bring up the same dispense pop-up window. The system will automatically calculate the total volume, and will appropriately restrict the Dispense steps so as they stay within the available volume of the instrument.

An even faster and easier way to add or remove dispense steps is to simply swipe one of the steps to the left. This will reveal a green DUPLICATE button as well as a red REMOVE button. Pressing the DUPLICATE button will add a copy of that step below the step that was swiped. Pressing the REMOVE button will delete that step.

	000.0 μL	none	5		
--	---------------------	------	---	--	--

NOTE: When there are only two steps, only the DUPLICATE button will be available. This is because there must always be at least two dispenses in a Variable Dispense program.

<input checked="" type="checkbox"/>	30.0 μL	<input checked="" type="checkbox"/> Rounded Bottom 2	<input type="checkbox"/>																											
	Dispense Volume	Destination	Speed																											
	<table border="1"> <tr><td>1</td><td>2</td><td>3</td></tr> <tr><td>4</td><td>5</td><td>6</td></tr> <tr><td>7</td><td>8</td><td>9</td></tr> <tr><td>.</td><td>0</td><td></td></tr> </table>	1	2	3	4	5	6	7	8	9	.	0		<table border="1"> <tr><td>None</td></tr> <tr><td>< Create New ></td></tr> <tr><td>Test 1</td></tr> <tr><td>Reservoir</td></tr> <tr><td>Rounded Bottom 2</td></tr> </table>	None	< Create New >	Test 1	Reservoir	Rounded Bottom 2	<table border="1"> <tr><td>1</td><td>6</td></tr> <tr><td>2</td><td>7</td></tr> <tr><td>3</td><td>8</td></tr> <tr><td>4</td><td>9</td></tr> <tr><td>5</td><td>10</td></tr> </table>	1	6	2	7	3	8	4	9	5	10
1	2	3																												
4	5	6																												
7	8	9																												
.	0																													
None																														
< Create New >																														
Test 1																														
Reservoir																														
Rounded Bottom 2																														
1	6																													
2	7																													
3	8																													
4	9																													
5	10																													
2		50.0 μL	none	8	<p>Select parameters above. Choose steps on left. Press Apply to assign those values to the selected steps.</p> <p><input type="button" value="Apply"/> <input type="button" value="Undo"/></p>																									
3		30.0 μL	Rounded Bottom 2	8																										
4		50.0 μL	none	8																										
5		30.0 μL	Rounded Bottom 2	8																										
<p><input type="button" value="Back"/> <input type="button" value="Select All"/> <input type="button" value="Ok"/> <input type="button" value="Cancel"/></p>																														

Another option for editing all the dispense steps at once is available by pressing the "Edit All" row when that feature is enabled. The screen above will be displayed and allow you to edit all the aspects of every dispense step at the same time. For more complex operations this option can be a valuable time saver. This feature can be enabled by checking the "Allow Edit All" box on the Pipetting screen within Settings (see [Section 4.8.2](#)).

Running a Variable Dispense program is very similar to a Repeat Dispense program. And similarly, there will be a Purge step at the end.

METTLER TOLEDO Rainin

Base Unit 001

000.0 μL

Reservoir

Step	Volume	Container	Speed
1	50.0 μL	Reservoir	8
2	20.0 μL	Air Gap	8
3	50.0 μL	Rounded Bottom 3	8
4	120.0 μL	none	8
5	+ Add Mix		

Program #4

New Program Save Help Settings

4.3.4 Dilute with Mix

The Dilute with Mix function will allow you to complete two aspirates with an air gap in between and a single dispense, with or without a mix. Pressing on either the first or third aspirate step will bring up a pop-up window identical to that of the standard simple pipette function. Pressing on the second aspirate will be similar, except that the container will be pre-defined as "none" and cannot be changed.

Volume	Source	Speed
20.0 μL	none	8

1 2 3

4 5 6

7 8 9

. 0 \times

1 6

2 7

3 8

4 9

5 10

Ok Cancel

Pressing on the dispense or add mix step will bring up pop-up windows that are also identical to the simple Pipette with Mix function. Except that the dispense volume is not editable because it is calculated automatically from the total aspirate volume.

Running a Dilute with Mix program is slightly different since there are multiple aspirate steps and only a single dispense, with or without a mix. Additionally, the second aspirate step will always be defined as an Air Gap. This means that when it comes time to aspirate, the tips should be floating up and out of any liquid so that only air is drawn up into the tips. Otherwise, the dispense and mix steps are identical to a simple Pipette program.

METTLER TOLEDO Rainin

Pipette Repeat Dispense Variable Dispense Dilute Multi Aspirate Favorites Custom

Step	Aspirate	Volume	Container	Speed
1	Aspirate	50.0 µL	Reservoir	8
2	Aspirate	20.0 µL	Flat Bottom 1	8
3	+ Aspirate			
4	Aspirate	70.0 µL	none	8
5	+ Add Mix			

Program #5 New Program Save Help Settings

Base Unit 001
000.0 µL
Reservoir

4.3.5 Multi-Aspirate with Mix

The Multi-Aspirate function allows you to complete multiple aspiration steps, then a single dispense with or without mix. This is similar to the Variable Dispense function but just aspirates instead. Pressing on any of the aspirate steps will allow you to edit that step.

Pressing on one of the aspirate steps brings up a pop-up window that is identical to those of the Simple Pipette with Mix program. The default is two steps, but simply press on the "+ Aspirate" row to add more. Similar to Repeat and Variable Dispense programs, swiping one of them to the left will reveal a green DUPLICATE button and a red REMOVE button. Pressing the DUPLICATE button adds a copy of that step below the step that was swiped. Pressing the REMOVE button deletes that step.

NOTE: If there are only two steps, then only the DUPLICATE button will be available. This is because there must always be at least two aspirates in a Multi-Aspirate program.

Pressing on the Dispense or Add Mix step will bring up pop-up windows that are identical to the simple Pipette with Mix function with one exception: the dispense volume is not editable because it is calculated automatically from the total aspirate volume.

Dispense Volume	Destination	Speed
<input checked="" type="checkbox"/> 30.0 µL	<input checked="" type="checkbox"/> Rounded Bottom 2	<input type="checkbox"/>

1	50.0 µL	none	8
2	30.0 µL	Rounded Bottom 2	8
3	50.0 µL	none	8
4	30.0 µL	Rounded Bottom 2	8

Select parameters above.
Choose steps on left.
Press **Apply** to assign those values to the selected steps.

Apply Undo

Back Select All Ok Cancel

Similar to Variable Dispense, another option for editing all the aspirate steps at once is available by pressing the "Edit All" row when that feature is available. The screen above will be displayed and allow you to edit every aspect of every step at the same time. For more complex operations this option can be a valuable time saver. This feature can be enabled by checking the "Allow Edit All" box on the Pipetting screen within Settings (see [Section 4.8.2](#)).

Running a Multi-Aspirate program is similar to the Variable Dispense program, except that it has multiple aspirations and only a single dispense. Otherwise all the operations are the same.



4.3.6 Custom

The Custom function gives you the ability to create any type of program that you might need. This includes unique step types that are only available within Custom programs, such as Aspirate with Turnaround, Dispense with Blowout, Purge, Instructions, Tip Change, Barcode and Manual (see [Step Type](#) section for more details).

Similar to all the above standard functions, just pressing on a step will allow you to edit it. However, in Custom programs the screen will look like this:



The main difference is that now you can select the type of step you would like to create. Once you have selected the step type, the rest of the pop-up window options will be displayed accordingly. In the case of standard steps – such as Aspirate, Dispense, and Mix – they are identical to what you have used before. Step types available in Custom programs are each a bit different.

The Aspirate with Turnaround step is a special type of aspiration step used whenever multiple dispenses are required from a single aspiration. The system will aspirate beyond the actual volume and then mechanically turnaround so that it is ready to dispense. For this step however, the user must also increase the aspirate volume by a small amount that will be discarded at the end. This discard volume is set by default to 1% of the nominal instrument volume in the standard Repeat and Variable Dispense programs (3.0 μL for the MicroPro 300 and 0.20 μL for the MicroPro 20). It is recommended to use this amount, unless the user has been able to verify a different volume under their particular circumstances. This discard volume, along with the mechanical turnaround, helps ensure that the final dispense in the sequence is accurate.

Step: 1 **Volume: 50.0 μL**

Allow Return To This Step After Purge Run Automatically

	Aspirate +	50.0 μL	Rounded Bottom 2	5
	Step Type	Volume	Source	Speed
^	Aspirate	1 2 3	none	1 6
+ ^	Aspirate w/ Turnaround	4 5 6	< Create New >	2 7
v	Dispense	7 8 9	Test 1	3 8
+ v	Dispense w/ Blowout	. 0 x	Reservoir	4 9
v	Mix		Rounded Bottom 2	5 10
v	Instruct		Test 2	
+ +	Purge		Test 3	
v v	Tip Change		Test 4	

< Active - Default > Ok Cancel

Liquid Class

When selecting the Instructions step, you are asked to provide the headline and instructions to be displayed. Once an Instructions step has been created, the headline of the instructions will be shown in the step on the main screen. In this case the volume and speed columns will be left blank.

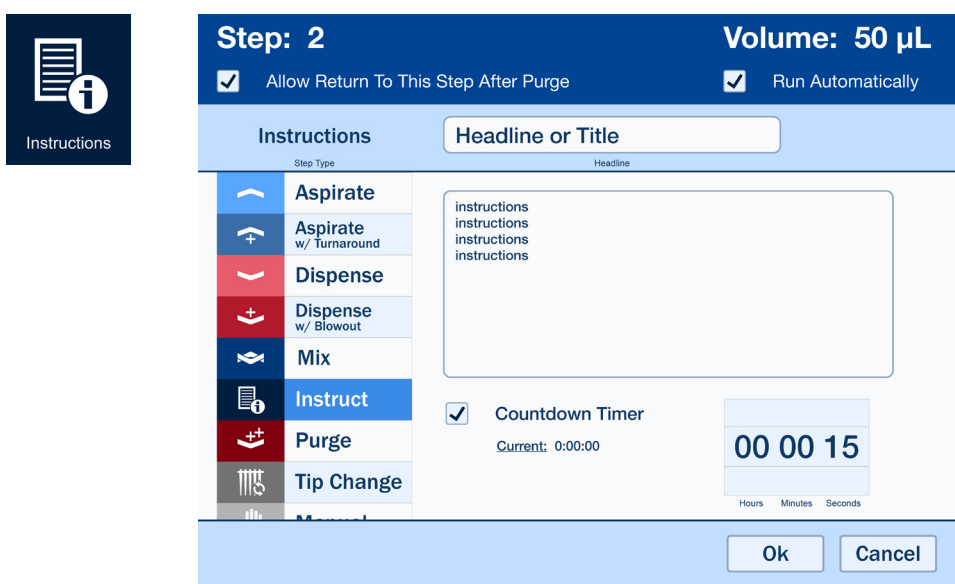

Step: 2 Volume: 50 µL

Allow Return To This Step After Purge Run Automatically

Instructions

Step Type Headline

Aspirate
Aspirate w/ Turnaround
Dispense
Dispense w/ Blowout
Mix
Instruct
Purge
Tip Change

instructions
instructions
instructions
instructions

Countdown Timer
Current: 0:00:00

00 00 15
Hours Minutes Seconds

Ok Cancel

When selecting a Dispense with Blowout step, the options available are essentially the same as any other standard dispense step. The only difference: at the end of the dispense step the unit will be taken all the way to blowout and essentially purge anything that is left in the tips.

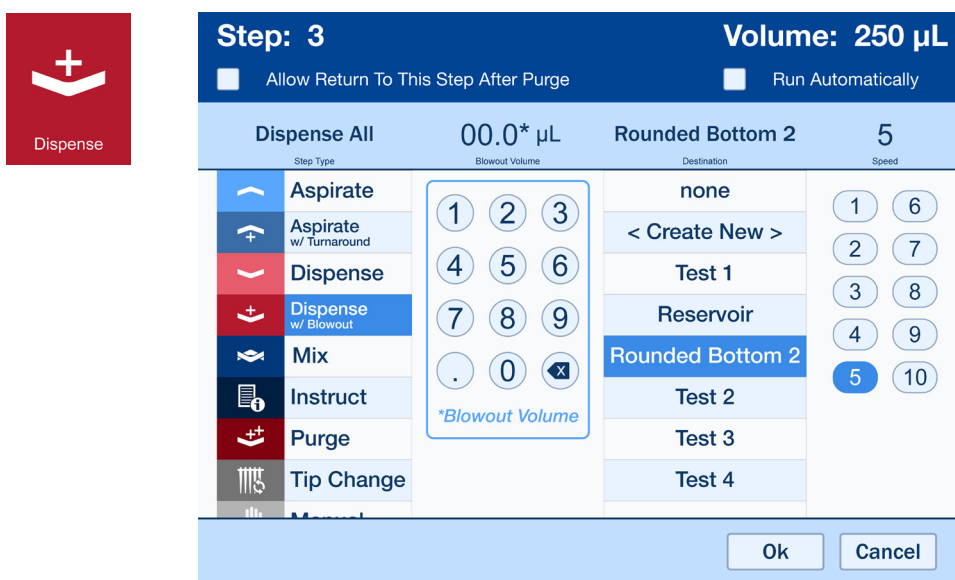

Step: 3 Volume: 250 µL

Allow Return To This Step After Purge Run Automatically

Dispense All 00.0* µL Rounded Bottom 2 5

Step Type Blowout Volume Destination Speed

Aspirate
Aspirate w/ Turnaround
Dispense
Dispense w/ Blowout
Mix
Instruct
Purge
Tip Change

1 2 3
4 5 6
7 8 9
. 0 ✕
*Blowout Volume

none
< Create New >
Test 1
Reservoir
Rounded Bottom 2
Test 2
Test 3
Test 4

1 6
2 7
3 8
4 9
5 10

Ok Cancel

A Tip Change step simply inserts a Tip Load, Tip Eject or full Tip Eject and Load cycle depending on your selections. This allows you to add a tip change anywhere within and is especially useful with long programs that require different types of tips to be used at different times. Note that you can specify whether filter tips should be used, however the instrument will not be able to explicitly verify that the installed tips are filter or non-filter.

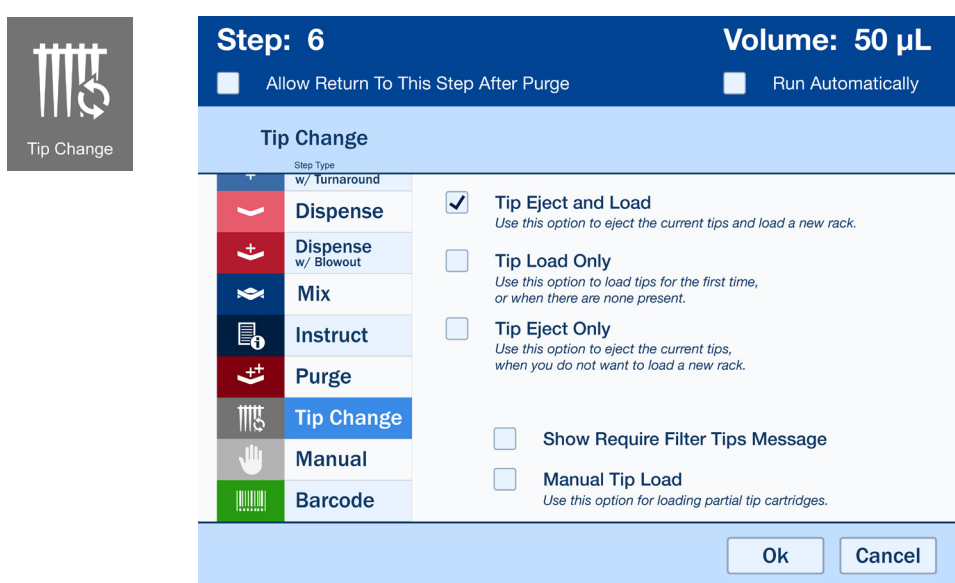

Step: 6 **Volume: 50 µL**

Allow Return To This Step After Purge Run Automatically

Tip Change

Step Type

- Dispense w/ Turnaround
- Dispense w/ Blowout
- Mix
- Instruct
- Purge
- Tip Change**
- Manual
- Barcode

Tip Eject and Load
Use this option to eject the current tips and load a new rack.

Tip Load Only
Use this option to load tips for the first time, or when there are none present.

Tip Eject Only
Use this option to eject the current tips, when you do not want to load a new rack.

Show Require Filter Tips Message

Manual Tip Load
Use this option for loading partial tip cartridges.

Ok Cancel

The Mix step in a Custom program is identical to the basic mix step used elsewhere. However, within Custom you can define the exact number of mixes you require.

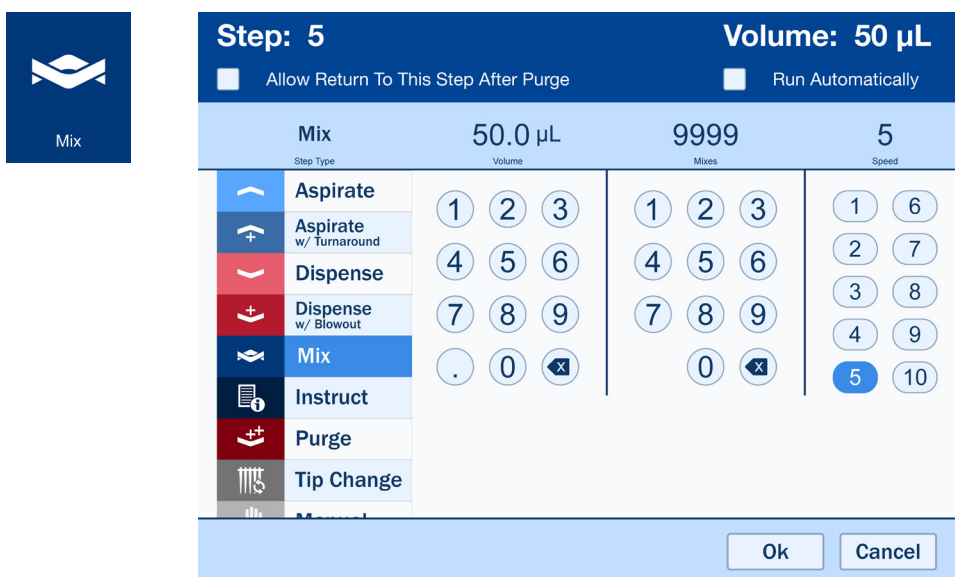

Step: 5 **Volume: 50 µL**

Allow Return To This Step After Purge Run Automatically

Mix 50.0 µL 9999 5

Step Type Volume Mixes Speed

- Aspirate
- Aspirate w/ Turnaround
- Dispense
- Dispense w/ Blowout
- Mix**
- Instruct
- Purge
- Tip Change
- Manual

1 2 3 4 5 6 7 8 9 0 X

1 2 3 4 5 6 7 8 9 0 X

1 2 3 4 5 6 7 8 9 0 X

Ok Cancel

When using a Barcode step you have the option to write a headline and instructions, just like an Instruction step. While running a Barcode step the headline and instructions will be displayed just like a normal Instruction step. However, there will now be a space for entering the barcode. You will also need to define the length or number of characters in the barcode.

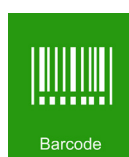

Step: 8 **Volume: 250 μ L**

Allow Return To This Step After Purge Run Automatically

Manual

Step Type: w/ Turnaround

Dispense instructions

Dispense w/ Blowout instructions

Mix Use Verification

Instruct Barcode Size: Check Digit:

Start	Length	Action	Value / Variable / Checkdigit Type

Proceed to next step on successful scan

Match Value

Verification Type Value Start Position Length

Match Value Enter the value that must match the portion of what was scanned at the selected starting position and entered length of characters.

Match Variable

Set Variable

Check Digit

To add barcode verification, press the Add button and the pop-up window above will be displayed. Here you will select the type of verification that you would like to use:

Match Value – Define a specific value to be verified, along with the exact start position within the barcode and the length or number of characters for this value. The scanned barcode must contain this exact value in the same position as defined.

Match Variable – Enter the name of a variable that has already been set using the Set Variable function below. Define the starting position and length of the barcode section that will be compared to this variable. The defined section of the scanned barcode must match the value in the set variable.

Set Variable – Enter the name of the variable you wish to set or define. Then enter the starting position and length or number of characters that will be taken from the scanned barcode and used to define this variable.

Check Digit – Select the type of check digit, then enter the starting position and length. The scanned barcode must contain the appropriate type of check digit in the position and length defined.

Manual mode in a custom program provides for incremental aspirate and dispense, and allows the user to stop aspirating or dispensing based on visual feedback. For example, if the volume of liquid in the wells of a microplate are not known, this function can be used to determine the volume by aspirating incrementally until the wells are empty. In this window you will define the initial volume increment, container and speed. While running a manual step you will have the option to adjust the volume increment and switch back and forth between Aspirate and Dispense.

 Manual

Step: 7 Volume: 250 μ L

Allow Return To This Step After Purge
 Run Automatically

Manual	2.0 μ L	Rounded Bottom 2	5
Step Type	Volume Increment	Source	Speed
w/ Turnaround			
Dispense	1 2 3	none	1 6
Dispense w/ Blowout	4 5 6	< Create New >	2 7
Mix	7 8 9	Test 1	3 8
Instruct	.	Reservoir	4 9
Purge	0	Rounded Bottom 2	5 10
Tip Change		Test 2	
Manual		Test 3	
Barcode		Test 4	

< Active - Default >
Ok
Cancel

Liquid Class

Most step types offer two additional options:

Allow Return to This Step After Purge – If you ever cancel or purge in the middle of running a program, this option allows you to return to any step that has this enabled. Rather than being forced to return all the way to the beginning of a program when a mistake is made, this feature allows you to return to any prior step that has this enabled and fits within the standard program logic.

Run Automatically – When enabled, the instrument will automatically perform the functions of this step without you pressing the run button on the instrument. This function is available for all step types within Custom, except for Tip Change or Manual steps.



CAUTION

When Run Automatically is used for Dispense, Mix or Purge steps, the instrument will immediately begin dispensing liquid in the tips as soon as the prior step in the program has completed. Ensure that the appropriate containers are located under the tips to prevent spills.

In most cases you will be able to put together any series of steps that you like. Custom truly is a blank slate that gives you the flexibility to perform any operations that you might otherwise not be able to accomplish. The only restrictions are programming steps that are beyond the capabilities of the instrument, such as aspirating more than the total volume allowed.

Running a Custom program is not that different than running any other program. In general, the only differences are the unique steps that are specific to Custom programs and the fact that the order of operations can be set to anything.

4.4 Favorites

METTLER TOLEDO Rainin		Pipette	Repeat Dispense	Variable Dispense	Dilute	Multi Aspirate	Favorites	Custom
Type	Name ▲	Description					Date	
≡	Program #2	description description					MM/DD/YYYY	
≡	Program #3	description description description description					MM/DD/YYYY	
≡	Program #4	description description					MM/DD/YYYY	
⌵	Program #5	description description					MM/DD/YYYY	
⌵	Program #6	description description					MM/DD/YYYY	
⌵	Program #7	description description					MM/DD/YYYY	
≡	Program #8	description description					MM/DD/YYYY	
⌵	Program #9	description description					MM/DD/YYYY	

Import Export Versions Load Program Search Help Settings

4.4.1 List Overview

The Favorites section contains a scrollable list of all saved programs. Each program is defined by an icon representing what type of program it is. In addition, each program has a name, description and the date/time it was last modified. You can also sort the list by clicking on the title for the name column. An arrow will appear showing which way it is sorted and you can reverse the direction by simply pressing it again. The bottom of the screen features a search function.

Select any program by pressing on it. Once selected, that program row doubles in size and is highlighted. Then, simply press the Load Program tab at the bottom of the screen to open the program and begin editing and/or running it.

To delete a program, swipe the row to the left to reveal a red REMOVE button. Pressing this will permanently delete the program.

From Favorites, you can also proceed directly to the Import and Export functions without having to go through the Settings screens. For more details on these functions, see the [Import/Export section](#).

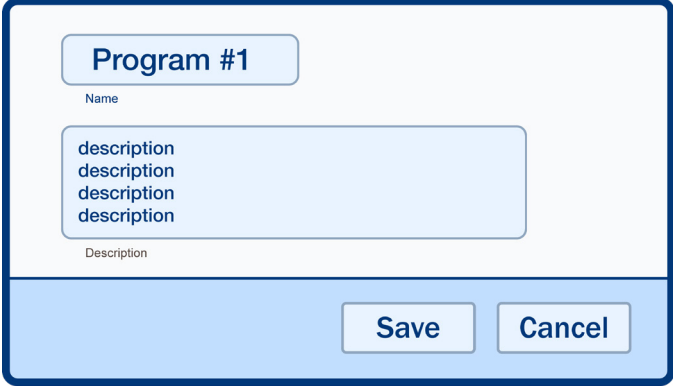

The image shows a screenshot of a software dialog box for saving a program. The dialog has a title bar at the top that says "Program #1". Below the title bar, there is a "Name" label followed by a text input field containing "Program #1". Below that is a "Description" label followed by a larger text area containing three lines of "description". At the bottom of the dialog, there are two buttons: "Save" and "Cancel".

4.4.2 Saving Programs

When editing or creating a program, save it by pressing the SAVE tab at the bottom of the screen will display the pop-up window above. Enter a name for the program and, if desired, a brief description. Then press SAVE and it will be added to the list of programs in Favorites.

NOTE: If you try to save a program with the same name as an existing saved program you will be warned that the existing one will be over-written.

Versions of Program #2					
Start Date:	<input type="text" value="YYYY/MM/DD"/>	End Date:	<input type="text" value="YYYY/MM/DD"/>	<input type="button" value="Apply"/>	
Type	Name	Ver	Description	Saved Date	Deleted Date
▼	Program #2	5	description description	MM/DD/YYYY	MM/DD/YYYY
▼	Program #2	4	description description	MM/DD/YYYY	MM/DD/YYYY
▼	Program #2	3	description description	MM/DD/YYYY	MM/DD/YYYY
▼	Program #2	2	description description	MM/DD/YYYY	MM/DD/YYYY
▼	Program #2	1	description description	MM/DD/YYYY	MM/DD/YYYY
<input type="button" value="Back"/>			<input type="button" value="Export"/>		

4.4.3 Versions

After selecting a program in Favorites, press the Versions tab to view a list of all the previously saved iterations of that program. From the Versions screen shown above you can also select each one and view the program details. Additionally, you can filter the list by a specific date range and export some or all of them. For more details on Export, see the [Import/Export section](#).

4.5 Tips

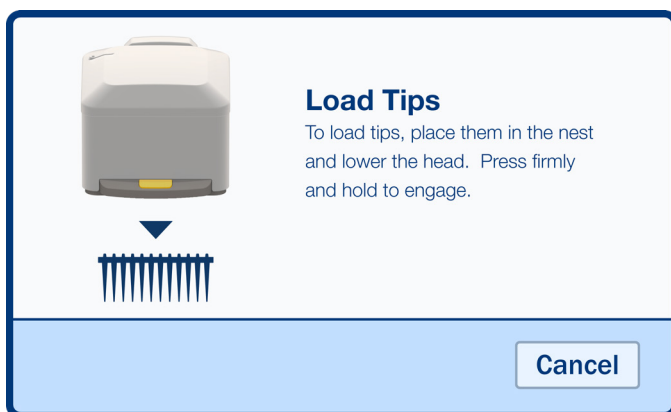

4.5.1 Load

The pop-up window above will be displayed if there are no tips loaded upon startup (if that setting is enabled) or after tip ejection.

To load tips, first place the rack of new tips on top of the nest. Then, bring the head down on top of the tips and press firmly. The instrument will automatically detect the presence of the tips and begin the loading process. Continue holding the head down firmly for a few seconds until loading is complete.

NOTE: To skip tip loading and continue working without tips loaded, press the CANCEL button in the pop-up window above. All programming and settings functions will be available and the Load Tips pop-up window will be displayed again once the RUN button is pressed.



4.5.2 Eject

To eject the current set of tips, press the EJECT button that is next to the image of the pipettor on the main screen. The pop-up window above will be displayed.

First, place an empty rack on top of the nest. Then bring the head down such that the tips are just starting to enter the rack. Then press the RUN button on the instrument to eject the tips into the rack. Once ejected you will be prompted to load a new set of tips.

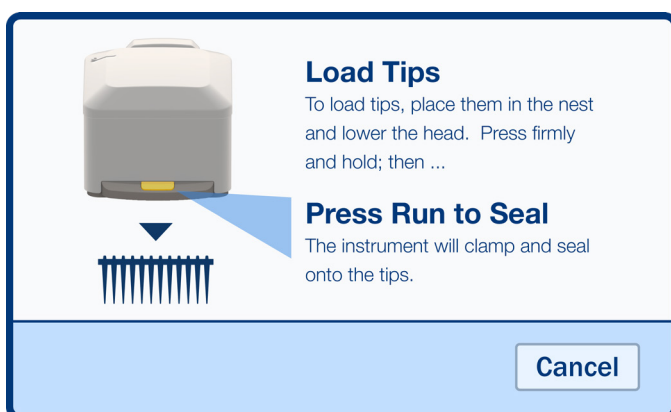

4.5.3 Manual Tip Load

When enabled in Settings, the Manual Tip Load option allows you to load tips without relying on the automatic tip sensing and clamp mechanism. This allows for you to load a partial rack of tips in any configuration.

When using Manual Tip Load, the pop-up window above will be displayed. The operation is identical to a normal tip load operation, except that after lowering the head onto the tips you will be required to push the Run button to initiate the clamp and sealing of the tips.

4.5.4 Types

Filtered sterile and non-filtered sterile tips can be used with any MicroPro model. However, only the appropriate volume tips can be used with the matching model of the instrument.

**CAUTION**

In order to maintain proper performance, only use the tips approved for use with the particular MicroPro model that you are using.

4.6 Pipetting Depth Recall

The Pipetting Depth Recall (PDR) feature allows you to save the exact height offset relative to the bottom of a particular container. This provides a quick and reliable way of making sure that the tips are appropriately positioned away from the bottom surface. It also greatly increases efficiency and speed throughout all your operations.

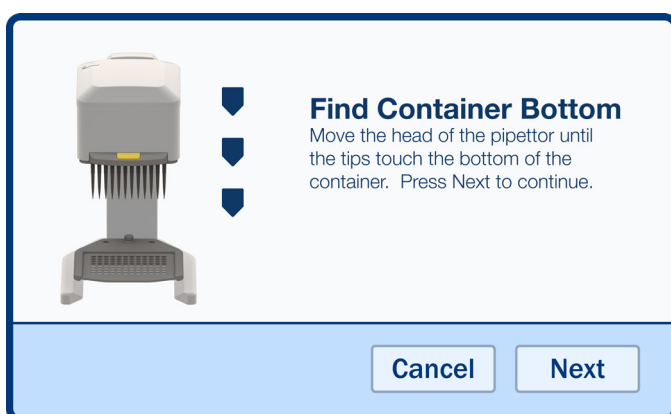

After pressing CREATE NEW from within the container selection list or [Settings](#), the pop-up window above will be displayed.

First, place the container on top of the nest or below it (in the case of a reservoir). Then, bring the head of the base unit down such that the tips are touching the bottom of the container. Hold the head in this position and press NEXT to continue.

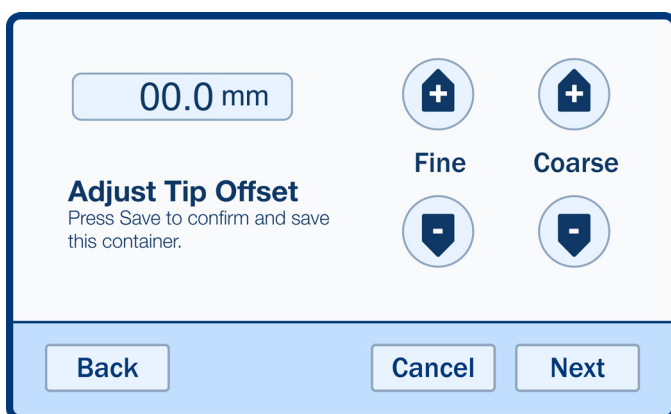

After pressing NEXT, the above pop-up will be displayed. While continuing to hold the tips down, press the FINE and COARSE adjustment buttons until you have reached the desired distance between the tips and the bottom of the container. Then, press NEXT and the pop-up below will be displayed.

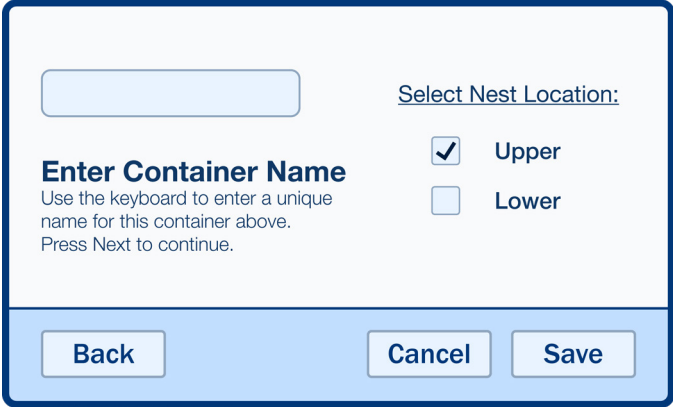

The screenshot shows a software dialog box with a light blue border. At the top left is an empty text input field. Below it, the text reads: **Enter Container Name**
Use the keyboard to enter a unique name for this container above.
Press Next to continue.

To the right of the input field, the text reads: Select Nest Location:
 Upper
 Lower

At the bottom of the dialog box, there are three buttons: **Back**, **Cancel**, and **Save**.

Here you will enter a name for the container and identify the nest location (Upper or Lower). Then press SAVE to save this container. Afterwards you will be taken back to wherever you were when you started this process.

4.7 Nest 96/384 Conversion

The nest platform can be easily converted to allow aspirating from or dispensing into 384-well microplates. Each side of the nest is labeled according to the size of microplate it is designed for. To change sides, simply loosen the nest mounting thumb nut, flip the nest platform over and re-secure with the thumb nut.

When using the nest for 384-well microplates, place the microplate onto the nest and push it into each corner. Each corner will align the tips with a specific quadrant of the 384-well microplate. You can aspirate or dispense normally.

4.8 Settings

4.8.1 Overview

Settings enable you to adjust a number of different options, view [calibration status](#), setup [liquid classes](#) or [containers](#), [import/export files](#), view the [data logs](#) and access the [advanced settings menu](#). The complete list of categories available is on the left side of the screen. Once selected, the detailed options appear on the right side. The BACK button on the bottom left will return you back to the main screen. Whenever a setting has been modified the SAVE button will become available on the bottom right. Once you are satisfied with the changes, simply press the SAVE button to apply those changes.

NOTE: If you attempt to leave a section after changes have been made without saving them, a warning pop-up will appear to inform you that the changes will be lost unless they are saved.

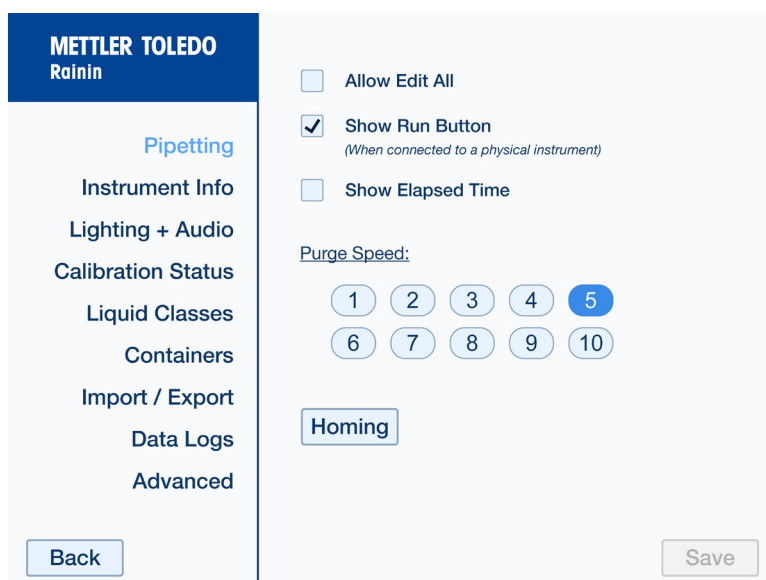

4.8.2 Pipetting

The first Settings category is Pipetting, where you can enable the “Edit All” function, show the RUN button and adjust the Purge Speed. Checking the box to allow “Edit All” enables this function within the Variable Dispense and Multi-Aspirate programs. For more information, see Sections [4.3.3](#) and [4.3.5](#) respectively.

Checking the box next to show RUN Button will displays the RUN button on the main screen. It will be located at the top of the instrument status image. This feature allows you to run each step of the program remotely from the tablet. For example, this can be quite useful if the instrument is under a hood during operation.

The Show Elapsed Time option displays the total time that has elapsed while running a program. The clock starts as soon as you run the first step and will stop upon completion of the last step. This will allow you to track how long it takes to run a particular program or protocol.

The Purge Speed setting defines the speed at which all Purge operations are conducted. Whenever there is a Purge step in any program, it will be done at the speed set here. There is also a Homing button that, when pressed, allows you to home the instrument.

METTLER TOLEDO
Rainin

- Pipetting
- Instrument Info**
- Lighting + Audio
- Calibration Status
- Liquid Classes
- Containers
- Import / Export
- Data Logs
- Advanced

[Back](#)

Instrument Name:

Model Number: MicroPro-300

Serial Number: 0123456789

Firmware Version: 2.44

Temperature: 72° F

App Version: 3.5.1

Installed: 2023/01/01 18:03:21

Language: English

Saved Programs: 27

4.8.3 Instrument Info

This section displays information about the instrument and the MicroPro Controller app. Specifically, it shows the current Instrument Name, Model Number, Serial Number, Firmware Version, Ambient Temperature, App Software Version, Date and Time the current version of the app was installed, the Language and the total number of programs saved.

The two things you can do in this screen are change instruments and modify the instrument name. To edit the name of the current instrument, press the button that the name is in. This allows you to edit and rename the instrument to anything you wish. Pressing on the “Change Instrument” button allows you to connect to any other available instrument (see [Section 4.1.1](#) for more details).

NOTE: The Instrument Name is what will appear in the list of available instruments in the Connection screen. This is also the name that will be displayed on the main screen after you are connected.

METTLER TOLEDO
Rainin

- Pipetting
- Instrument Info
- Lighting + Audio
- Calibration Status
- Liquid Classes
- Containers
- Import / Export
- Data Logs
- Advanced

Back

LED Brightness:

off
 1
 2
 3
 4
 5

LED Auto Off Delay (minutes):

never
 5
 15
 30
 60

Play Chime After Every Step

Play Chime When Instruction Timer Ends

Save

4.8.4 Lighting + Audio

Here you can turn on and off the deck lighting, as well as control the brightness. You can also define the time period after which the deck lighting turns off due to inactivity. Finally, there are two sound effect options. The Play Chime After Every Step option will trigger a simple ding sound after the completion of every step in any program that is being run. The Play Chime When Instruction Timer Ends will only play the ding sound after the timer on an instruction step ends. This can be helpful if you have stepped away from the instrument while it was running, as it will notify you upon the completion of each step.

METTLER TOLEDO
Rainin

Current Calibration Status

Calibration Type: **Factory**

Current Values: **Factory**

Last Modified: **YYYY/MM/DD 00:00:00**

Modified By: **Factory**

Factory Calibration Date: **YYYY/MM/DD 00:00:00**

Reminder

Duration: **Disabled**

Needed After:

Last Reset:

[View Calibration Log](#)

Pipetting
Instrument Info
Lighting + Audio
Calibration Status
Liquid Classes
Containers
Import / Export
Data Logs
Advanced

[Back](#)

4.8.5 Calibration Status

This section displays the current calibration status, type, current values, date last modified and the name entered when it was last modified. You can also view the Calibration Log, which will have the complete history of any and all changes made to the instrument calibration. The status of the maintenance reminder is also shown on this screen.

METTLER TOLEDO
Rainin

	Name ▲	Calibration Values	Date
< Create New >			
Pipetting Instrument Info Lighting + Audio Calibration Status Liquid Classes Containers Import / Export Data Logs Advanced	Liquid #1	15.0 300.0 15.9 298.1	YYYY/MM/DD 00:00:00
	Liquid #2	50.0 51.3	YYYY/MM/DD 00:00:00
	Liquid #3	25.0 280.0 23.6 278.4	YYYY/MM/DD 00:00:00
Versions			

[Back](#)

4.8.6 Liquid Classes

Here you will create and maintain the calibration settings for all the special liquids that you use. The list contains the name of each liquid class, their settings and creation date.

Liquid classes can be used during any sequence of pipetting operations in any program. Within each Aspirate step edit pop-up or screen you can select one of these liquid classes to use. Each following step in the sequence will continue to use the active liquid class specified unless changed.

Liquid #1

Name

300.0 μL

Selected High Calibration Point
300.0

50.0 μL

Selected Low Calibration Point
50.0

One Point Only

301.1 μL

Actual High Value
300.0

49.8 μL

Actual Low Value
50.0

Allowed Aspirate Speeds



<input checked="" type="checkbox"/>	<input checked="" type="checkbox"/>	<input checked="" type="checkbox"/>	<input checked="" type="checkbox"/>	<input checked="" type="checkbox"/>	<input checked="" type="checkbox"/>	<input checked="" type="checkbox"/>	<input checked="" type="checkbox"/>	<input checked="" type="checkbox"/>	<input checked="" type="checkbox"/>	<input checked="" type="checkbox"/>
1	2	3	4	5	6	7	8	9	10	
<input checked="" type="checkbox"/>	<input checked="" type="checkbox"/>	<input checked="" type="checkbox"/>	<input checked="" type="checkbox"/>	<input checked="" type="checkbox"/>	<input checked="" type="checkbox"/>	<input checked="" type="checkbox"/>	<input checked="" type="checkbox"/>	<input checked="" type="checkbox"/>	<input checked="" type="checkbox"/>	<input checked="" type="checkbox"/>

Allowed Dispense Speeds

Save

Cancel

To create a new liquid class, press on the top row labeled Create New. The pop-up window above will be displayed. Here you can enter in the name of the special liquid and the desired calibration values, along with the subsequent actual values. Specify the values using either a One Point or Two Point calibration. You can also specify the pipetting speeds that are allowed to be used with each liquid class defined.

METTLER TOLEDO Rainin		Name ▲	Calibration Values		Date
		< Create New >			
Pipetting		Liquid #1	75.0 68.5	250.0 235.6	YYYY/MM/DD 00:00:00
Instrument Info		50.0 48.2	275.0 264.8	YYYY/MM/DD 00:00:00	 
Lighting + Audio		Liquid #3	75.0 72.5	250.0 244.7	YYYY/MM/DD 00:00:00
Calibration Status					
Liquid Classes					
Containers					
Import / Export					
Data Logs					
Advanced					
Back		Versions			

To modify or remove a liquid class that has already been created, swipe that row to the left to reveal the Modify and Remove buttons (see image above). Once you select a liquid class, you can also press the Versions button which will display all the previously saved iterations of that liquid class. Here, you can also view and export detailed specifications of each version.



When actively using a liquid class other than the system default, a blue icon with the name of the selected liquid class is shown on the main screen next to the instrument image (see image above).

METTLER TOLEDO Rainin		Name ▲	Offset	Date
Pipetting		< Create New >		
Instrument Info		Plate #1	Lower + 7.6 mm 0.4 mm	YYYY/MM/DD 00:00:00
Lighting + Audio		Plate #2	Lower + 3.2 mm 0.6 mm	YYYY/MM/DD 00:00:00
Calibration Status		Plate #3	Upper + 2.1 mm 0.8 mm	YYYY/MM/DD 00:00:00
Liquid Classes				
Containers				
Import / Export				
Data Logs				
Advanced				
Back		Versions		

4.8.7 Containers

Here a complete list of all saved containers is organized by name and displays the offset distance and date it was created or last modified. It also shows the nest position (Upper or Lower) used when the container was created.

You can also create new containers by simply pressing < Create New > on the top row. To modify or remove existing containers, swipe the desired row to the left to reveal the corresponding buttons.

METTLER TOLEDO Rainin			
Pipetting		Import	Import any combination of programs, containers, and liquid classes from Files.
Instrument Info		Export	Export any combination of programs, containers, liquid classes, or data logs.
Lighting + Audio		Export - All	Export all programs, containers, liquid classes and logs on this iPad.
Calibration Status		Manage Files	View / Delete files used for Importing, or created by Exporting data.
Liquid Classes			
Containers			
Import / Export			
Data Logs			
Advanced			
Back			

4.8.8 Import/Export

This section offers four options: Import, Export Custom, Export All and Manage Files. Selecting Import brings you to a new screen where you can import any combination of programs, containers and liquid classes from the JSON files on your iPad. The first screen (shown below) lists those files and allows you to select any number of them to import.

Import		
<input type="button" value="Select All"/> <input type="button" value="Deselect All"/>		
	File Name	Date
<input type="checkbox"/>	Export 2021Y_10M_22D_13H_15M_05S.json	YYYY/MM/DD 00:00:00
<input checked="" type="checkbox"/>	Export 2021Y_10M_22D_13H_19M_05S.json	YYYY/MM/DD 00:00:00
<input checked="" type="checkbox"/>	Export 2021Y_10M_22D_18H_15M_05S.json	YYYY/MM/DD 00:00:00
<input type="checkbox"/>	Export 2021Y_10M_25D_13H_15M_05S.json	YYYY/MM/DD 00:00:00
<input type="checkbox"/>	Export 2021Y_11M_12D_13H_15M_05S.json	YYYY/MM/DD 00:00:00
<input checked="" type="checkbox"/>	Export 2021Y_11M_15D_13H_08M_45S.json	YYYY/MM/DD 00:00:00
<input type="checkbox"/>	Export 2021Y_12M_22D_10H_07M_56S.json	YYYY/MM/DD 00:00:00
<input type="button" value="Back"/> <input type="button" value="Next"/>		

After selecting the desired file(s) and pressing the NEXT button, a new screen is shown (see below). This screen has one tab each for programs, containers and liquid classes. After making a selection from the Programs Tab, press the Include Containers and Liquid Classes button to automatically select all containers and liquid classes used by the selected program(s). This helps ensure that you import all the items necessary to run the desired programs. Once finished, press the Import button to bring all the items into the app.

Import					
Select All		Deselect All		Include Containers and Liquid Classes	
Type	Model	Name ▲	Description	Date	
<input type="checkbox"/>		MicroPro 20	Program #2	description description	MM/DD/YYYY
<input checked="" type="checkbox"/>		MicroPro 20	Program #3	description description	MM/DD/YYYY
<input checked="" type="checkbox"/>		MicroPro 300	Program #4	description description	MM/DD/YYYY
<input type="checkbox"/>		MicroPro 300	Program #5	description description	MM/DD/YYYY
<input type="checkbox"/>		MicroPro 300	Program #6	description description	MM/DD/YYYY
<input checked="" type="checkbox"/>		MicroPro 300	Program #7	description description	MM/DD/YYYY
<input type="checkbox"/>		MicroPro 300	Program #8	description description	MM/DD/YYYY
<input type="checkbox"/>		MicroPro 20	Program #9	description description	MM/DD/YYYY

Back Import

Choosing Export – Custom will take you to a screen that is very similar to the second Import screen. Here you can export any combination of programs, containers, liquids and logs. The following two images show the container screen and the log screen. As you can see, the log screen allows you to select the log and the start/end date that you wish to export. If you do not specify a date range for the log, the entire log will be included.

Export			
Select All		Deselect All	
Name ▲	Offset	Date	
<input type="checkbox"/>	Plate #1	Lower + 7.6 mm 0.4 mm	MM/DD/YYYY 11:59 AM
<input checked="" type="checkbox"/>	Plate #2	Lower + 3.2 mm 0.6 mm	MM/DD/YYYY 11:59 AM
<input checked="" type="checkbox"/>	Plate #3	Upper + 2.1 mm 0.8 mm	MM/DD/YYYY 11:59 AM

Back Export

Export | Programs | Containers | Liquids | **Logs**

Select All | Deselect All

Name ▲ | Date Range

<input type="checkbox"/>	Pipetting Activity Log	Start Date: <input type="text"/> <small>YYYY/MM/DD</small> End Date: <input type="text"/> <small>YYYY/MM/DD</small>
<input checked="" type="checkbox"/>	Connection Log	
<input checked="" type="checkbox"/>	Settings Log	
<input type="checkbox"/>	Calibration Log	
<input type="checkbox"/>	Error Log	
<input checked="" type="checkbox"/>	System Log	

Back | Export

After making your selection and pressing the Export button, the pop-up window shown below displays a summary of all items that are being exported. You can also modify the name for the JSON file and decide whether you would simply like to save it to Files on the tablet or send it to another device via Airdrop. If you choose Airdrop, the standard options are made available. Using Airdrop is an extremely simple way of sharing programs from one tablet to another.

Export Summary

Export_2022Y_05M_19D_17H_46M_37S .json

Programs	4
Containers	7
Special Liquids	1
Logs	4

Save to Files | Airdrop | Cancel

If you choose Export – All, you will be presented with the screen below. Here you have the ability to select the complete set of files for each category.

Export All	
<input type="button" value="Select All"/>	<input type="button" value="Deselect All"/>
Name ▲	
<input type="checkbox"/>	Programs (All Versions)
<input checked="" type="checkbox"/>	Containers (All Versions)
<input checked="" type="checkbox"/>	Liquid Classes (All Versions)
<input type="checkbox"/>	Pipetting Activity Log
<input type="checkbox"/>	Connection Log
<input checked="" type="checkbox"/>	Settings Log
<input checked="" type="checkbox"/>	Calibration Log
<input type="checkbox"/>	Error Log
<input type="checkbox"/>	System Log
<input checked="" type="checkbox"/>	Instrument Values
<input type="button" value="Back"/>	<input type="button" value="Export"/>

After making your selection and pressing the Export button, a similar export summary pop-up window will give you the option to modify the name of the JSON file and, again, choose whether to save it to Files on the tablet or use Airdrop. This is the fast and simple way of creating a complete backup of the entire app. If you ever lose the tablet, use this file to restore the replacement tablet to the state the lost tablet was in when the Export operation was executed.

NOTE

The logs cannot be imported, but the information is still available within the JSON file.

4.8.9 Data Logs

This section shows the data logs for the instrument. View each log by pressing on the name and specifying a date range. If no date range is specified, the entire log is shown.

METTLER TOLEDO
Rainin

- Pipetting
- Instrument Info
- Lighting + Audio
- Calibration Status
- Liquid Classes
- Containers
- Import / Export
- Data Logs
- Advanced

Back

Start Date (YYYY/MM/DD):

End Date (YYYY/MM/DD):

Name	Date
Pipetting Activity Log	YYYY/MM/DD 11:59 AM
Connection Log	YYYY/MM/DD 11:59 AM
Settings Log	YYYY/MM/DD 11:59 AM
Calibration Log	YYYY/MM/DD 11:59 AM
Error Log	YYYY/MM/DD 11:59 AM
System Log	YYYY/MM/DD 11:59 AM
Login/Logout Log	YYYY/MM/DD 11:59 AM

Pipetting Activity Log – Displays every program and tip eject/load operation that has been executed using this particular tablet. Each entry contains the type, name, version number, description, date and timestamp of when it was executed. Selecting each entry shows the details of the program or operation. From here you can also modify the date range of entries being displayed as well as sort them by date and time, name, version and type.

Pipetting Activity Log

Start Date: End Date:

Type	Name	Ver	Description	Run On
	Program #2	5	description description	MM/DD/YYYY
	Program #8	1	description description	MM/DD/YYYY
	Program #37	12	description description	MM/DD/YYYY
	Program #1	4	description description	MM/DD/YYYY
	Program #19	27	description description	MM/DD/YYYY

Connection Log – A record of each connection or attempted connection that this tablet made to an instrument. Each entry contains the serial number of the instrument as well as the date and time of the event. Select any entry to view additional details.

Settings Log – A record of every change made to any of the app settings, including the name of the setting, the value that was changed and the date/time of the modification. Selecting a particular entry will bring up the details on its own screen.

Calibration Log – A record of each change made to the calibration of an instrument using this tablet. This includes factory and user calibrations. Each entry will identify the instrument serial number, type of calibration, calibration values, the name entered when the changes were made and the date/time of the change. Selecting an entry provides a detailed view.

Error Log – A record of any errors that a connected instrument or the app detected. Each entry will include the serial number of the instrument, the name or description of the error, and the date/time that it was detected. Selecting a particular entry brings up the details on its own screen.

System Log – A record of all the actions performed by the system. Each entry contains the serial number of the connected instrument, name of the action performed and the date/time it was executed. Selecting an entry provides a detailed view.

Login/Logout Log – A record of each time the app was opened or started while the Require User Name setting was enabled. If that setting is enabled, every user will be required to make an entry under their username in order to start the app. These entries are recorded here and include the username entered and the date/time they started the app. Selecting a particular entry brings up the details on its own screen.

4.9 Advanced Settings

4.9.1 Overview

This section provides a new submenu of advanced options, including calibration and security. A complete list of sections is in the left column, just like the standard settings screen. Pressing the BACK button returns you to the standard Settings screen. Navigating and saving changes here works exactly like it does on the regular settings screen.

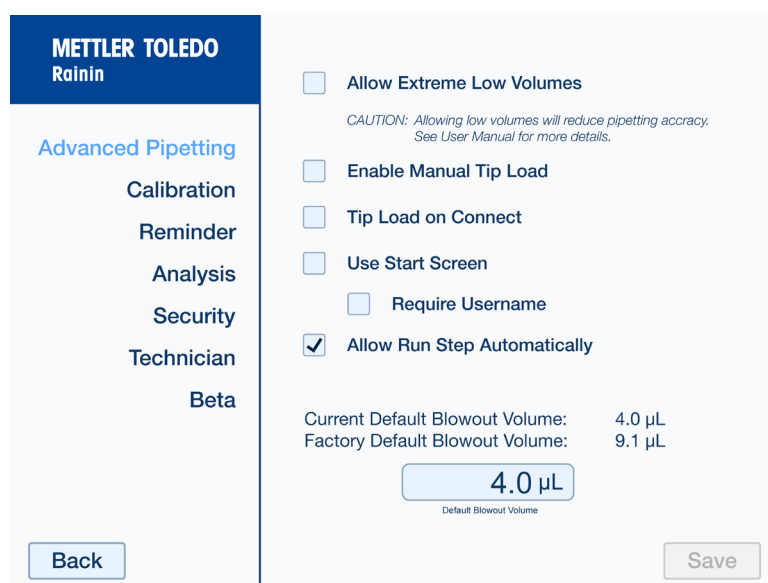

4.9.2 Advanced Pipetting

Advanced Pipetting provides a number of options that will affect the normal operation of the MicroPro Controller app. The Allow Extreme Low Volumes option reduces the minimum pipetting volume from the standard 5 µL down to 2 µL for the MicroPro 300 and from 1 µL down to 0.5 µL for the MicroPro 20.



CAUTION

Allowing extreme low volumes will reduce pipetting accuracy at those volumes. It is strongly recommended that you verify performance prior to pipetting below the standard allowable volume range of your instrument.

See [Section 4.5.3](#) for more details on Manual Tip Load. The Tip Load on Connect option immediately shows the tip load pop-up window upon connection to the instrument.

See [Section 4.3.6](#) for more details on the Allow Run Step Automatically option. Checking this option allows all users to enable this functionality on any custom program step where it is allowed.

The Use Start Screen setting shows a new screen (shown below) that displays a large start button when initially connecting to an instrument. There is also an Exit button in the upper left hand corner of the main pipetting screen that takes you back to this start screen. You also have the option to Require User Name. This provides a text box where all users must make some entry before progressing to the main pipetting screen. This entry is recorded in the logs for any operation performed by this user during this session.

NOTE

The username is not verified in any way, so the app will accept any entry of valid characters.

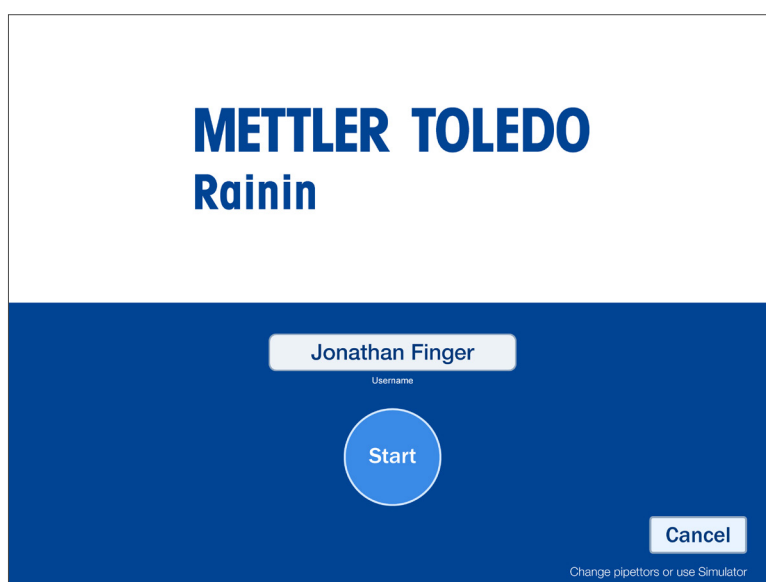

The Advanced Pipetting screen also provides the option to modify the default blowout volume. This will universally affect all programs where a blowout is performed and the actual value depends on the MicroPro model being used.

4.9.3 Calibration

Here you can change the type of calibration your instrument is operating under. By default the instrument operates under Factory Calibration. This is the normal operating state that has been calibrated by the factory to ensure the accuracy and repeatability of the instrument across the normal operating volume range. These settings cannot be altered, however Rainin recommends that users follow Good Laboratory Practices (GLP) and perform maintenance checks at regular intervals to ensure proper operation.

If desired, other types of calibration are available. You can select from either a Custom One Point or Two Point calibration. This will adjust the settings of the instrument on top of the factory calibration.

METTLER TOLEDO
Rainin

Advanced Pipetting
Calibration
Reminder
Analysis
Security
Technician
Beta

Factory Calibration
 Custom One Point
 Custom Two Point

Current Values: 300.0 / 298.1 and 50.0 / 49.8
Last Modified: YYYY/MM/DD 00:00:00
Last Modified By: John Doe

Jane Doe
Modified By

300.0 µL
Selected High Calibration Point

298.1 µL
Actual High Value

50.0 µL
Selected Low Calibration Point

49.8 µL
Actual Low Value

Calibrate Upper Nest
Calibrate Lower Nest

Back Save

After selecting a Custom Two Point calibration, the screen above is displayed. Here you can enter the desired calibration values along with the subsequent actual values. This will adjust the instrument's calibration curves accordingly. A Custom One Point calibration is functionally the same, but with only a single adjustment point.

There is an option to re-calibrate the upper and lower nest positions. The nest positions are calibrated at the factory, however you may need to re-calibrate the nest position if using a Dual Nest Accessory. The process is simple: to calibrate the lower nest, simply press on the Calibrate Lower Nest button to display the pop-up window below.



Follow the instructions and lower the head until the tips pass through the upper nest and rest on the table or lower nest position. Continue to hold the head in this position and press the NEXT button. The instrument will automatically detect and re-calibrate the lower nest position. Once this is complete, a new pop-up window will tell you that the nest calibration is complete.

To calibrate the upper nest, simply press on the Calibrate Upper Nest button to display the pop-up window below.

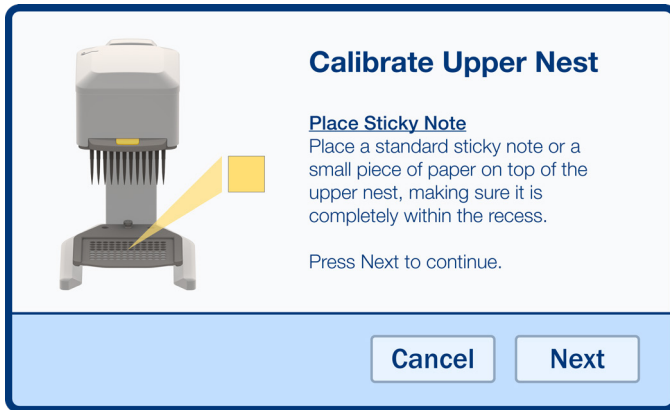

Follow the instructions and place a single sticky note or small piece of paper on the upper nest. Then, bring the head down until the tips are resting on the paper as shown in the pop-up window below. Do not press so hard as to deform the paper.



Continue to hold the head in this position and press the NEXT button. The instrument will automatically detect and recalibrate the upper nest position. Once finished, a similar completion message will be displayed.

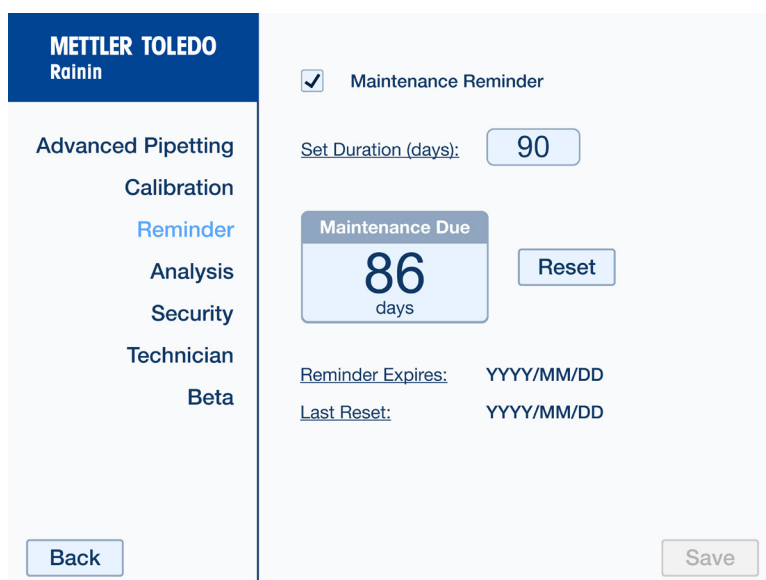

4.9.4 Reminder

Here you can turn on/off the Maintenance Reminder and set its duration in days. You can also reset the reminder, see when it expires and see when it was last reset. This is a helpful tool that can ensure the instrument is checked at regular intervals.



When the reminder elapses, a red exclamation point symbol is shown next to the image of the pipettor on the main screen (see image above). Pressing on this symbol will tell you that it is time for maintenance.

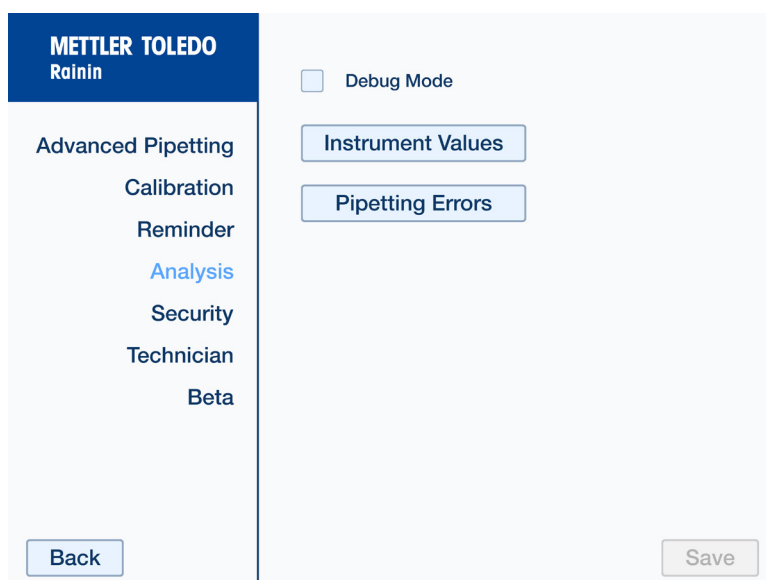

4.9.5 Analysis

This section provides access to a number of tools for analyzing and diagnosing potential issues with the instrument. Specifically, you can put the app into a "Debug Mode" that will display some additional information that might be helpful when investigating a particular issue. The setup values for the connected instrument can also be reviewed from this screen. You can also view the Pipetting Errors log directly from here.

NOTE

Issues with the app and instrument are rare. Even so, [Rainin Technical Support](#) can assist you in resolving any issues as quickly as possible.

METTLER TOLEDO
Rainin

Advanced Pipetting
Calibration
Reminder
Analysis
Security
Technician
Beta

Back

Set Password Protection:

Advanced Menu

App Lockdown

Save

4.9.6 Security

You can set two levels of password protection for the MicroPro Controller app. Check boxes allow you to turn each level of protection on/off independently. When the Advanced Menu password protection is turned on, users will only be able to access the Advanced Settings menu if they enter a password. This helps protect some of the more critical settings, such as Calibration, from inadvertent changes.

When App Lockdown protection is enabled, the user will only be able to run pre-existing programs. They will not be able to edit existing programs or create new ones.

When activating this feature, ensure the box is checked, then enter the desired password and press SAVE. Once you exit this section you will be required to enter the password before you can return and modify the security settings.

Write down your password in a safe place. However, when this security feature is enabled, a Password Recovery button will also be displayed. If you forget your password, press this button and you will be provided with a special code. Write this code down and contact Rainin Technical Support at tech.support@rainin.com. They will use this code to recover your password.

4.9.7 Technician

This area is for service personnel only and is password protected. If you need assistance with your instrument, contact Rainin technical support at tech.support@rainin.com.

4.9.8 Beta

This section provides access to potential new MicroPro Controller app features being evaluated. These features are still in the beta test phase and therefore their performance and functionality cannot be guaranteed. For more information about these features or to provide your feedback, please contact your local sales representative.

5. Troubleshooting

5.1 General Errors

Issue	Possible Causes	Solutions
Tablet is unresponsive.	Depleted battery.	Charge the battery using the cable and power supply provided. Note that a fully depleted battery will require a few minutes to reach a minimum charge level.
	Tablet turned off.	Ensure the tablet is on. Refer to the user manual provided with the tablet.
Instrument is unresponsive.	Power cord unplugged.	Ensure that the power cord is plugged into a working power outlet.
Auto-loading of tips does not occur, or tips do not load properly	Incorrect tip cartridges being used.	Check the tip cartridge and ensure they are authorized for use with your instrument. See Section 4.5.3 .
	Tip rack not properly seated in nest.	Ensure tip rack is properly seated and aligned in the nest.
	Adequate pressure not applied during loading.	Apply a sufficient amount of downward pressure on the head of the instrument during tip loading.
Liquid dripping from the tips.	Tips don't load properly.	See above.
	Sealing surfaces damaged.	Contact your METTLER TOLEDO or Rainin service representative. See Section 6.3 .
Tips do not aspirate evenly.	Tips don't load properly.	See above.
	Tips not fully submerged in liquid throughout aspiration.	Ensure tips are fully submerged and change PDR setting if needed.
	Internal seal failure.	Perform leak test by aspirating 300 μ L. If any drips occur within 2 minutes scontact METTLER TOLEDO or Rainin service. See Section 6.3 .
Dispense volume is inaccurate.	Damaged tips.	Try a new set of tips to see if the problem persists.
	Incorrect calibration being used.	Ensure Custom Calibration has been set properly and that Special Liquids Calibration has not been turned on accidentally.
	Aspirate or dispense speed set too high.	Reduce speed as needed.

5.2 Wireless Connection Errors

Issue	Possible Causes	Solutions
Lost connection between tablet and instrument.	Instrument does not power on.	Ensure the instrument is plugged into a working power outlet.
	Bluetooth connection on tablet has been turned off.	Open Settings on the tablet and activate Bluetooth (refer to the user manual provided with the tablet). Close and restart the app.
	Distance between the tablet and the instrument is too great.	Bring the tablet closer to the instrument.
Tablet connected to the wrong instrument.	Tablet automatically connected to the last instrument used.	Go to Settings>Instrument Information. Press the Change Instrument button and select the desired Instrument from the list.
Desired instrument does not appear in the list of available units.	Instrument does not power on.	Ensure the instrument is plugged into a working power outlet.
	Distance between the tablet and the instrument is too great.	Bring the tablet closer to the instrument.

6. Care and Maintenance

The MicroPro pipetting system is designed for easy care and use in the recommended laboratory environment. Avoid using the instrument in a dusty or damp environment and keep the instrument as clean as possible.

6.1 Cleaning

We recommend that the instrument be cleaned at least once a month. All outer surfaces of the instrument can be cleaned using a clean cloth and a mild detergent. For easy cleaning of the base, remove the nest to easily clean both sides. The nest is autoclavable if necessary.

**WARNING**

The instrument must be disconnected from electrical power prior to cleaning in order to avoid the risk of electric shock and damage to the instrument.

**CAUTION**

Avoid spilling liquid onto the pipetting head or into the instrument tower. This could lead to instrument damage and/or improper functionality.

Do not use any aggressive solvents or chemicals on the instrument. This could result in damage to the instrument and/or improper functionality.

6.2 Decontamination

Parts that may have been contaminated with potentially hazardous substances should be cleaned with a damp cloth and 10% bleach solution or any other appropriate disinfectant. Decontamination is the sole responsibility of the owner and/or operator of the instrument. For more information, or if you have any questions regarding decontamination contact, Rainin Technical Support at tech.support@rainin.com.

Prior to sending a unit in for service, or having the unit serviced in the field, it must be decontaminated if it has come into contact with radioactive or hazardous substances.

6.3 Calibration and Service

METTLER TOLEDO and Rainin provide service and calibration for the MicroPro. We recommend preventive maintenance and calibration be completed on your instrument at least once a year or according to your internal SOP. ISO 17025 certificates are available and can be requested from your local sales representative. Any service must be performed by a factory-trained technician with original parts to maintain instrument reliability and performance. To schedule a service or calibration, go to www.mt.com/rainin and click "Contact Us". In the U.S., go to ShopRainin.com and click on Service.

For more information on user calibration and special liquids, see Sections [4.8.5](#) and [4.8.7](#) above.

**WARNING**

Do not open the instrument enclosure. There are no user-serviceable parts inside.

7. Technical Specifications

7.1 Performance Specifications

	MicroPro 300	MicroPro 20
Channel Accuracy	300 μL : $\pm 1.0\%$ (3.0 μL) 150 μL : $\pm 1.5\%$ (2.25 μL) 30 μL : $\pm 1.5\%$ (0.45 μL) 15 μL : $\pm 2.0\%$ (0.3 μL)	20 μL : $\pm 1.0\%$ (0.20 μL) 10 μL : $\pm 1.5\%$ (0.15 μL) 2 μL : $\pm 5.0\%$ (0.10 μL)
Channel Precision	300 μL : $\leq 1.0\%$ (3.0 μL) 150 μL : $\leq 1.0\%$ (1.5 μL) 30 μL : $\leq 1.0\%$ (0.3 μL) 15 μL : $\leq 2.0\%$ (0.3 μL)	20 μL : $\leq 0.5\%$ (0.10 μL) 10 μL : $\leq 1.0\%$ (0.10 μL) 2 μL : $\leq 3.0\%$ (0.06 μL)

7.2 Weight and Dimensions

	MicroPro 300	MicroPro 20
Length	216 mm (8.5 in)	240 mm (9.5 in)
Width	190 mm (7.5 in)	190 mm (7.5 in)
Height	320 mm (12.6 in)	320 mm (12.6 in)
Weight	5 kg (11 lbs)	5 kg (11 lbs)

7.3 Power Supply

Input (AC)	100-240V 1.6A 50-60Hz
Output (DC)	24V 2.5A

7.4 Test Conditions

Details regarding the standard test conditions are available upon request. Please contact Rainin in the U.S. or your local METTLER TOLEDO office. In the U.S. dial +1 800 4 RAININ (800 472-4646) or email techsupport@rainin.com. Outside the U.S. go to www.mt.com/rainin and use the Contact Us button in the navigation bar.

7.5 Environmental

Environment	Only for use indoors.
Usage Temperature	18°C - 35°C
Relative Humidity	55% - 75% (non-condensing)

8. Ordering

To order tips, accessories or additional instruments, please contact your local Rainin sales representative in the U.S. or your local METTLER TOLEDO office. In the U.S., call +1 800 4 RAININ (800 472-4646). Outside the U.S. go to www.mt.com/rainin and use the Contact Us button in the navigation bar.

9. Regulatory Information

EC Declaration of Conformity according to ISO 17050

Visit mt.com/Rainin-MicroPro



FCC Note

This device complies with Part 15 of FCC Rules. Operation is subject to the following two conditions: 1. This device may not cause harmful interference. 2. This device must accept any interference received, including interference that could cause undesired operation.



RoHS Regulation 2011/65/EU

Rainin and METTLER TOLEDO fulfill requirements under RoHS Regulation 2011/65/EU. Accessories comply with the above mentioned RoHS regulation.

MicroPro Regulatory Certifications:

Metter-Toledo Rainin, LLC, 7500 Edgewater Dr., Oakland, CA 94621, USA

United States	Contains FCC ID: XPNINAB1	
Canada	Contains IC: 8595A-NINAB1	
Europe		  
Australia & New Zealand		
United Kingdom		
Japan	Contains: 204-610006	
Singapore	Complies with IMDA Standards DB106440	
South Korea	KC ID: R-R-M7R-MP Contains: MSIP-CRM-ULX-NINA-B111	
Taiwan	Contains Transmitter Module 內含發射器模組: CCAJ16LP6470T3	
China	Contains: CMIIT: 2021DJ2218 该设备已经获得中国无线电发射设备型号核准证书: CMIIT ID: xxxxxxxxxx	
BT SIG	Declaration ID: D065268 Contains QD ID: 100763	

www.mt.com/rainin

For more information

Mettler-Toledo Rainin, LLC
7500 Edgewater Drive
Oakland, California 94621 USA

Subject to technical changes
© 2023 Mettler-Toledo Rainin, LLC
30852451 Rev. B